



Operating instructions
Laboratory washer
PLW 8617

To avoid the risk of accidents or damage to the machine, it is **essential** to read these instructions before it is installed and used for the first time.

en - GB, AU, NZ



Notes about these instructions	6
Appropriate use	7
User profiles	8
Product description	9
Appliance overview	9
Control elements on the display.....	11
Main menu.....	11
Programme start display	13
Warning and Safety instructions	18
Symbols on the machine.....	22
Main menu	24
Main menu.....	24
Actions in the Main menu.....	24
Changing the display language 	25
Login 	25
Logout	26
Documentation	26
Opening and closing the door.....	28
Areas of application	29
General information	29
Transfer trolley	29
Load carriers	29
Preparing the load items	30
Preparing the load	31
Before starting a programme	33
After the end of a programme	33
Laboratory glassware and utensils.....	34
Programme overview.....	35
General programmes.....	36
Programmes for specific soiling	37
Programmes for specific load items.....	38
Additional programmes	39
Service programme	39
Chemical processes and technology	40
Dispensing liquid chemical agents	44
Dispensing systems	44
Containers for process chemicals.....	45
Filling containers with process chemicals.....	46
Filling the dispensing system	47
Operation	48
Switching the machine on and off.....	48
Loading the wash chamber	48
Selecting a programme	49
Selecting a load carrier.....	49
Selecting programmes from Favourites	50
Starting the programme	51

Contents

Programme sequence	51
End of programme.....	51
Cancelling a programme	52
Programme cancellation with manual disinfection.....	52
Delay start	53
Network connection	54
Network connection	54
Network protocols	55
Process documentation	55
System settings	56
System	56
Network connections	56
Changing the PIN	57
Pairing	58
Assign write permissions.....	59
Setting the network	60
Configuring the printer	61
Certificate presentation	62
Machine functions	63
Automatic system test.....	63
Carrying out self-disinfection (optional).....	64
Starting the continuous programme.....	65
Filling the dispensing system	66
Filter maintenance	66
Dispensing system setup	67
Calibrating the conductivity meter	69
Carrying out a programme test	70
Restarting	72
Opening the data plate.....	72
Managing favourites	73
Maintenance	74
Periodic checks	74
Routine checks.....	75
Cleaning the filters in the wash cabinet	76
Cleaning the spray arms.....	77
Cleaning the machine.....	79
Locking the display	79
Checking mobile units, modules and inserts	81
Built-in printer (optional)	82
Replacing the paper roll	82
Thermal paper	83
Error messages and instructions	84
Representation of faults on the display.....	84
In main menu.....	84
In the programme sequence	84
Technical faults on the machine	85
List with active messages	85
Troubleshooting.....	86
Technical faults without fault number.....	87

After sales service	88
Electrical connection	89
Electromagnetic compatibility (EMC)	90
Plumbing	91
Technical data	92
Caring for the environment	93
Appendix	96
User rights in the Main menu	96
User rights in the System menu	97
Power levels of the programmes/mobile units/module combinations	98
Power levels of the programmes/Mobile units/Module combinations for the APLW 511 .	101
Optional extras	102

Notes about these instructions

Important warnings

 Information which is important for safety is highlighted in a thick framed box with a warning symbol. This alerts you to the potential danger of injury to people or damage to property. Read these warning notes carefully and observe the procedural instructions and codes of practice they describe.

Notes

Information of particular importance that must be observed is highlighted in a thick framed box.

Additional information and comments

Additional information and comments are contained in a simple frame.

Operating steps

Operating steps are indicated by a black square bullet point.

Example:

- Select an option using the arrow buttons and save your choice with *OK*.

Display

Certain functions are shown in display messages using the same font as that used for the function itself in the display.

Example:

Settings  menu.

The PLW 8617 laboratory washer is designed to reprocess laboratory glassware, utensils and similarly categorised components using water-based media.

Appropriate use

Reprocessing encompasses the cleaning, rinsing and – where necessary – thermal disinfection and drying of the following load items:

- Vessels such as beakers, flasks, cylinders and test tubes
- Measuring vessels such as measuring cylinders, volumetric flasks and pipettes
- Dishes such as petri dishes and watch glasses
- Plates such as slides and sequencing plates
- Small items such as lids, magnetic stirring rods, spatulas and stoppers
- Other items such as boxes, plastic flasks and containers, metal parts, pipe and hose pieces and funnels

The laboratory washer is generally referred to as “the machine” in these operating instructions. The term “load items” is used wherever the items to be processed are not defined in any further detail. The term “wash water” is used for the mixture of water and process chemicals.

Reprocessing is carried out in conjunction with:

- Process chemicals which are tailored to the result of the reprocessing
- Load carriers which are tailored to the load items

Observe the information issued by the manufacturer of the load items.

Inappropriate use

The PLW 8617 laboratory washer must not be used for any purposes other than the appropriate use described. This applies in particular to:

- The reprocessing of medical devices that can be reprocessed
- Use in the catering industry
- Domestic use

User profiles

User administration

Access to the machine is restricted to a certain group of people. Authorised users are entered in User management via the machine's web interface. User management is described in the programming manual.

A User ID and PIN are required for the user Login on the machine. User actions such as starting a reprocessing programme are saved. User data is read out on the Reprocessing report, for example.

User profiles

Day-to-day use

For day-to-day use, operators must be instructed on the basic functions and how to load the machine and must also be trained regularly. They must have a basic knowledge of machine reprocessing of laboratory glassware and utensils.

Day-to-day work is carried out using the following user levels:

- Without login
- Automatic
- Operator

Service work

Adaptations of the machine, e.g. to accessories used or on-site conditions, require additional specific knowledge of the machine.

It is carried out using the following user levels:

- Technician
- Administrator

Administration

Changes to the reprocessing process and performance testing also require specialist knowledge about machine reprocessing of laboratory glassware and utensils and about process technology.

It is carried out using the following user level:

- Administrator

Appliance overview

Infeed and out-feed side

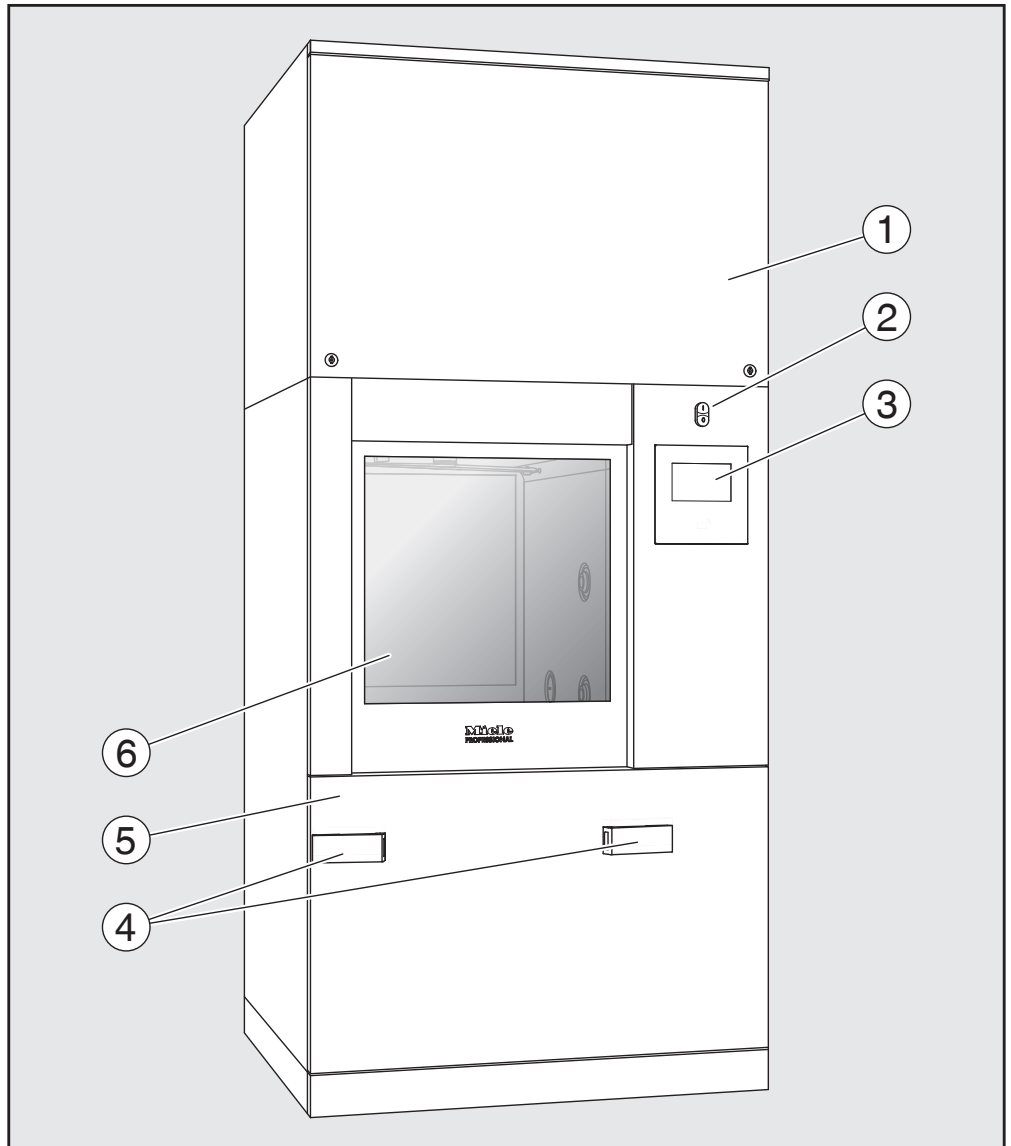

- ① Service panel for service staff
- ② **I/O** power switch
- ③ Display
- ④ Docking system for transfer trolley,
service panel lock
- ⑤ Service panel
- ⑥ Door closed

Product description

Infeed and out-feed side without service panel

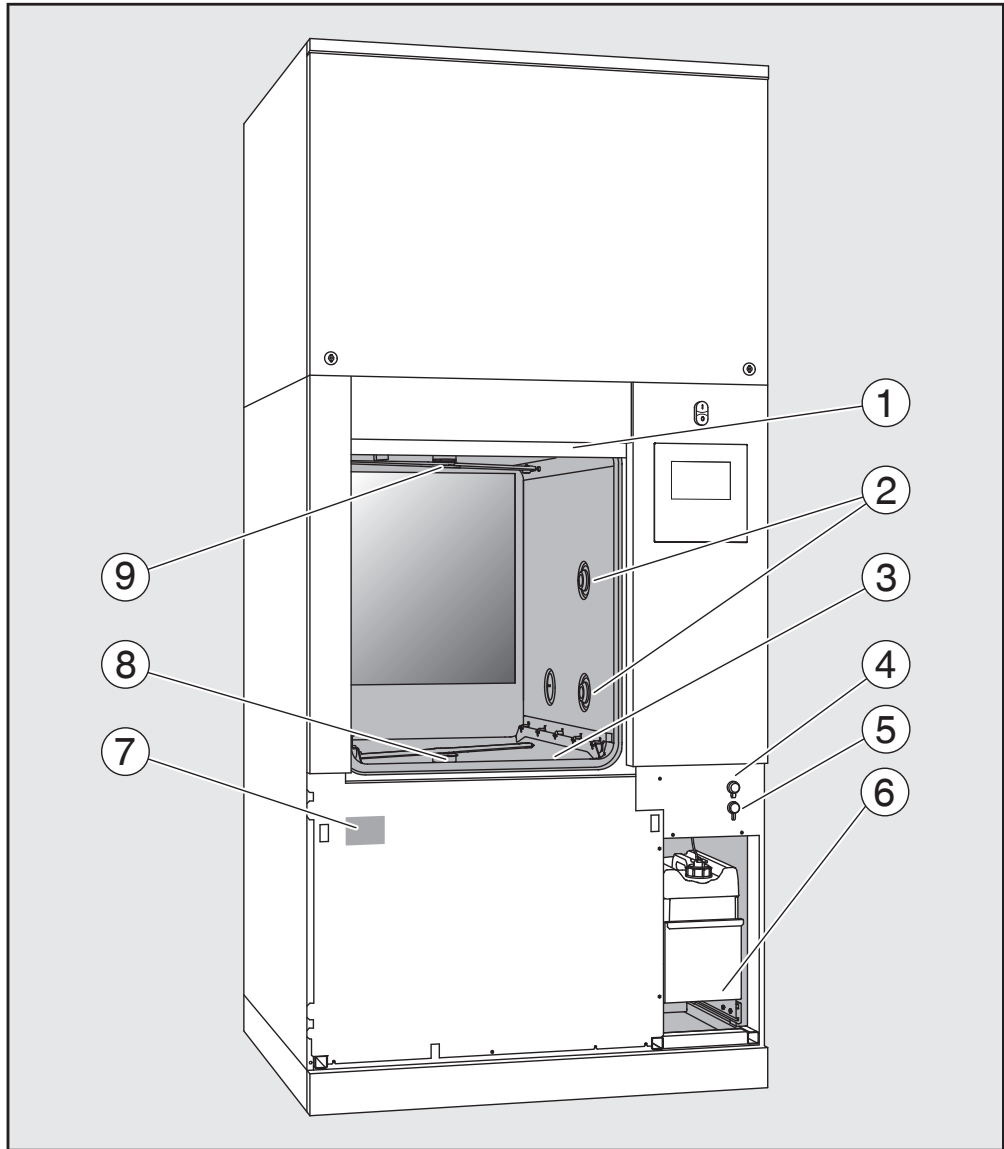

- ① The door is open
- ② Water supply for load carriers
- ③ Filter combination
- ④ USB port
- ⑤ Connection for Miele Customer Service Department
- ⑥ Drawer with containers and connections for process chemicals
- ⑦ Data plate
- ⑧ Lower machine spray arm
- ⑨ Upper machine spray arm

Control elements on the display

Main menu

The machine display shows the control elements light on a black background. In these operating instructions, the display is shown as black on a light background in order to improve legibility.

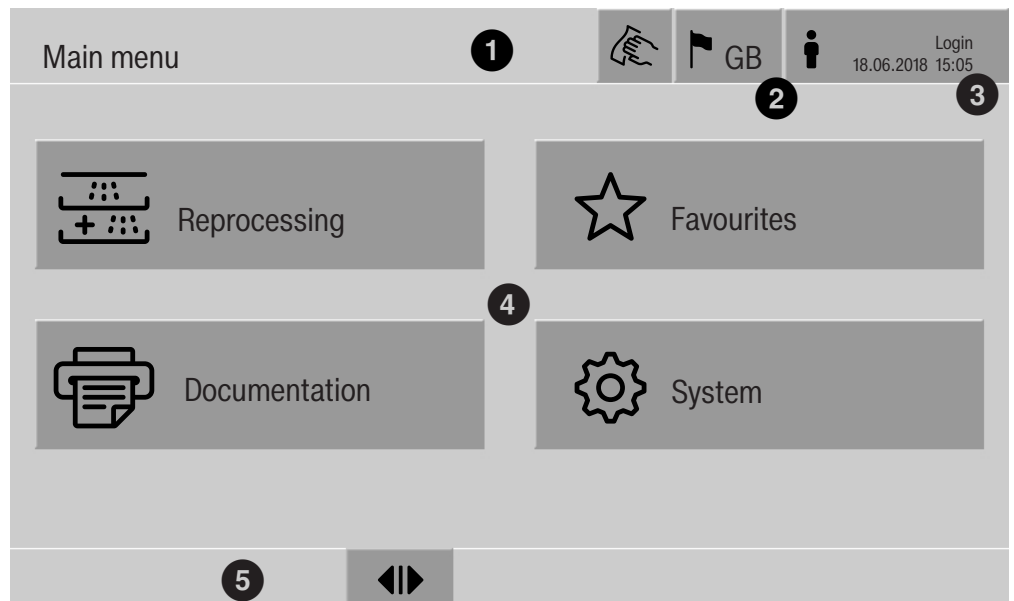

- ① Header
- ② Display language selected
- ③ Current user
- ④ Buttons to call up sub-menus
- ⑤ Footer

Buttons for all enabled actions are displayed in the footer.





If a menu is split across several pages, a scroll bar will be displayed above the footer. Swipe the display or tap the scroll bar to scroll between the pages.

Buttons in the main menu/ header





Symbol	Description/function of the button
	Locks the display, e.g. for surface disinfection
	Opens the Select display language menu. The language currently set is indicated behind the symbol, e.g. GB
	Opens the login or logout dialog, e.g. to switch users

Product description

Symbols in the main menu

Symbol	Description/function of the button
 Reprocessing	Opens the list of reprocessing programmes which are assigned to the load carrier
 Favourites	Opens the list of favourites
 Documentation	Opens the list of available reprocessing reports
 System	Opens the configuration menu, e.g. for network settings or to change the PIN
i	Information
	Please wait, the controls are busy

Buttons in the main menu/footer

Symbol	Description/function of the button
	Warning present, opens the Messages list
	Fault present, opens the Messages list
	Opens the door
	Closes the door
	The door is locked

Buttons in the sub-menu/footer

Symbol	Description/function of the button
	Leave menu, go back to previous menu level, do not save entries
OK	Confirm entries

Programme start display

Once the Reprocessing load carrier, for example, has been selected in the A 500 menu and the associated Universal reprocessing programme has been confirmed, the following is displayed:

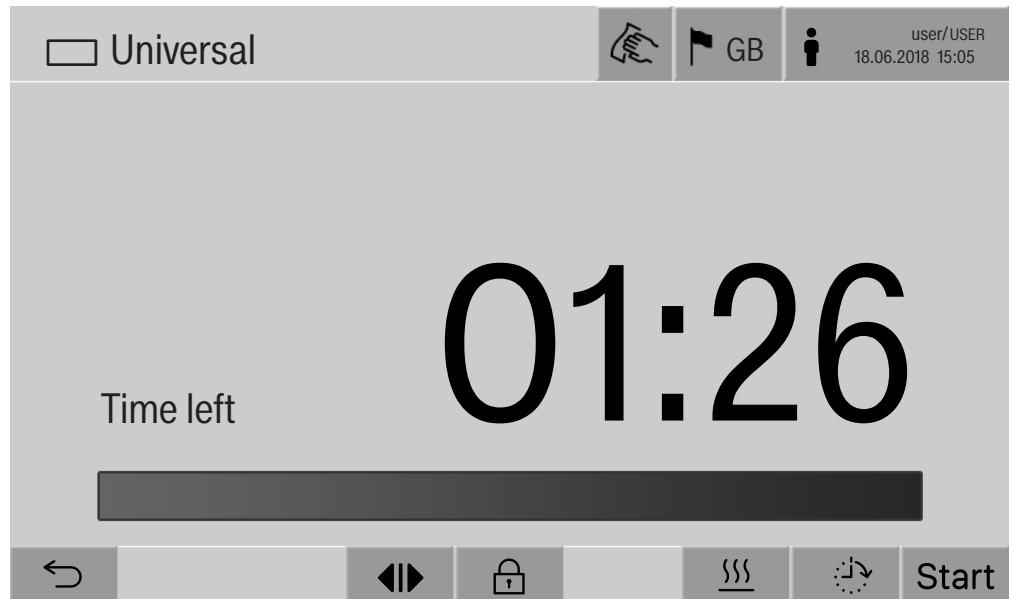

The pictogram of the load carrier and the selected reprocessing programme are displayed in the header.







The duration and a progress bar are shown on the display.

The colour of the progress bar corresponds to the current machine status:

- Black for ready for use
- White for an ongoing reprocessing programme
- Green for a reprocessing programme that has been successfully completed
- Yellow for warnings
- Red for faults

Product description

Programme start/
programme se-
quence buttons/
symbols

Symbol	Description/function of the button
Start	Programme start
Stop	Programme cancellation
	Opens the input screen for selecting the start time
	Door locked
	Shows the programme sequence display in the default view
In/Out	Schematic programme sequence display, contains information for the Customer Service Department
	Displays the programme sequence as a diagram
	Selects the steam heating method
	Selects the electric heating method
	Selects the electric and steam heating method
- (next to the progress bar)	Displays the current faults and warnings in the progress bar

Heat-up
context menu (op-
tional)

This context menu is only available in machines where it is possible to switch the energy supply from electric to steam.

The energy source for heating can be changed before and during the programme sequence. The selected setting is used for heating up the wash water and the demineralised water in the demineralised water tank.

The selected setting is applied permanently in the machine controls.



Press the  button to open the context menu.

Example of a programme sequence display

After the programme has started, the following display is shown:

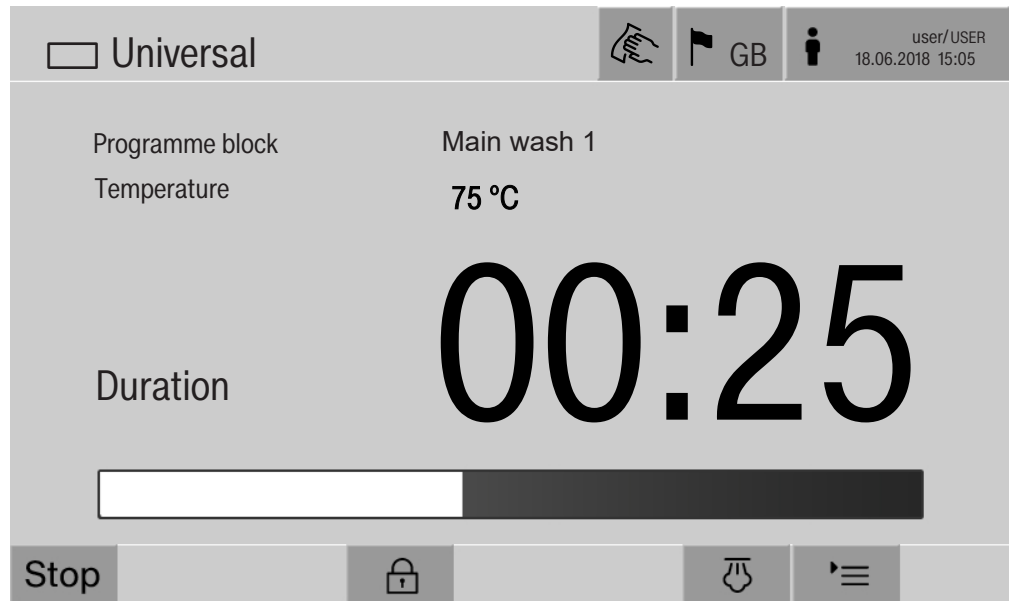

The current programme phase and the temperature reached are also shown on the display.

The progress bar indicates the ratio between the duration and the time left.

Programme sequence display context menu

During the programme sequence, you can choose between 4 views:

- Standard ☰
- Table 📊
- In/Out chart – In/Out
- Graphical 📈



Press the ☰ button to open the context menu.

Product description

Table programme sequence display

Once you have switched to the table display of the programme sequence using the  button, the following data is shown:

- Block name
- Time remaining in the programme phase
- Holding time
- Programme parameters with the associated expected and actual values and minimum/maximum values achieved

You can scroll to other pages using the scroll bar.

The maximum possible programme parameters are as follows:

- Material number and Date of manufacture of the mobile unit
- Cycle number
- User information: First name, Last name, User level
- Temperature of the wash water, measured values from sensors 1 and 2
- Temperature in the dispensing phases 1 to 3, measured values of sensors 1 and 2
- Temperature of the air during drying inside in phases 1 and 2
- Temperature of the air during drying outside in phases 1 and 2
- Water volumes in the programme step and the programme phase
- Dispensed quantities of the dispensing systems used
- A0 value
- Conductivity in the water intake and drainage
- Wash pressure for the inner wash water circuit and the PowerPulse-Cleaning
- Spray arm speeds

In/Out chart programme sequence display

The In/Out chart contains information about the input signals (page 1), the output signals (page 2) and specific sensor measurements:

- Wash water temperature
- Air temperature
- Circulation pump wash pressure
- Conductivity

This information is used by service staff and is not explained in these operating instructions.

Graphical programme sequence display

Once you have switched to the graphical view of the programme sequence using the  button, the following values are displayed as curves:

- Wash water temperature [W]
- Air/external-drying temperature [EA]
- Air/internal drying temperature [IA]
- Internal wash pressure [P]

Warning and Safety instructions

 Risk to health and risk of damage if the operating instructions are not followed.

Failure to follow the operating instructions – and in particular the safety instructions and warnings they contain – may result in persons being seriously injured or property being seriously damaged. Read these operating instructions carefully before using the machine. This will prevent both personal injury and damage to the machine.

Keep the operating instructions in a safe place.

Correct application

► Use of the machine is only permitted for the applications expressly approved in the operating instructions. Alterations or conversion of the machine, or using it for purposes other than those for which it was intended, are not permitted and could be dangerous.

The cleaning and disinfection processes are only designed for laboratory glassware and utensils which are designated as reprocessable by the manufacturer. The information provided by the manufacturer of the load items must be observed.

► This machine is intended for indoor use only.

► The machine is equipped with a special bulb to cope with particular conditions (e.g. temperature, moisture, chemical resistance, abrasion resistance and vibration). This special bulb must only be used for the purpose for which it is intended. It is not suitable for room lighting. Replacement lamps may only be fitted by the Miele Customer Service Department.

Risk of injury

Please pay attention to the following notes to avoid injury

► This machine must be commissioned, serviced and repaired by a Miele authorised and trained service technician only. To ensure compliance with Good Laboratory Practice guidelines, Miele repair and maintenance contracts are recommended. Unauthorised repairs can pose considerable risks to the user.

► Do not install the machine in an area where there is any risk of explosion or of freezing conditions.

► The electrical safety of the machine can only be guaranteed when it is correctly earthed. It is essential that this standard safety requirement is observed and regularly tested. If in any doubt, please have the electrical installation inspected by a qualified electrician.

► A damaged or leaking machine could be dangerous and compromise your safety. Disconnect the machine from the mains immediately and call the Miele Service Department.

Warning and Safety instructions

- ▶ Label machines which have been taken out of operation and secure them from being switched on again without authorisation. The machine may only be put back into operation once it has been successfully repaired by the Miele Customer Service Department.
- ▶ Personnel operating the machine should be trained regularly. Untrained personnel must not be allowed access to the machine or its controls.
- ▶ Take care when handling chemical agents. These may contain irritant, corrosive or toxic ingredients.
Please observe the chemical agent manufacturer's safety instructions and safety data sheets.
Wear protective gloves and goggles.
- ▶ The machine is designed for operation with water and recommended additive chemical agents only. Organic solvents and flammable liquid agents must not be used in it.
This could cause an explosion, damage rubber or plastic components in the machine and cause liquids to leak out of it.
- ▶ The water in the cabinet must not be used as drinking water.
- ▶ Be careful when sorting items with pointed ends. Position them in the machine so that you will not hurt yourself or create a danger for others.
- ▶ Broken glass can result in serious injury when loading or unloading. Damaged glass items must not be reprocessed in the machine.
- ▶ When using this machine in the higher temperature ranges, be especially careful not to scald or burn yourself or come into contact with irritant substances when opening the door. Where disinfecting agents are used there is a danger of inhaling toxic fumes.
- ▶ Where there is a risk of toxic or chemical substances occurring in or leaking into the suds solution (e.g. aldehyde in the disinfecting agent), it is essential to regularly check door seals and make sure that the steam condenser is functioning correctly. Opening the machine door during a programme interruption carries particular risks in such circumstances.
- ▶ Should personnel accidentally come into contact with toxic vapours or chemical agents, follow the emergency instructions given in the manufacturer's safety data sheets.
- ▶ After using the hot air drying unit, open the door to allow the everything in the cabinet from the load itself to the mobile units, modules and inserts to cool down.
- ▶ Mobile units, modules, inserts and the load must be allowed to cool down before they are unloaded. Any water remaining in containers could still be very hot. Empty them into the wash cabinet before taking them out.

Warning and Safety instructions

- ▶ Steam heating is permissible up to a pressure of 1000 kPa. This corresponds to a water steam temperature of 180 °C.
- ▶ Never clean the machine or near vicinity with a water hose or a pressure washer.
- ▶ There may be a risk of slipping if liquid is spilt on the floor depending on the type of flooring and footwear being worn. Keep the floor dry where possible and take care to clean up any liquid spills straight away. Take the necessary precautions when cleaning up hazardous substances and hot liquids.
- ▶ The machine must be disconnected from the mains electricity supply before any maintenance or repair work is carried out.

Quality assurance

The following points should be observed to assist in maintaining quality standards when processing laboratory glassware and utensils to avoid damage to the loads being cleaned.

- ▶ If it is necessary to interrupt a programme in exceptional circumstances, this may only be done by authorised personnel.
- ▶ The standard of cleaning and disinfection must be routinely confirmed by the user. The process should be validated on a regular basis, and checked against documented control results.
- ▶ For thermal disinfection, use temperatures and temperature holding times to achieve the required infection prophylaxis in accordance with current health and safety regulations.
- ▶ Make sure items being washed are suitable for machine reprocessing and are in good condition. Plastic items must be thermally stable. Nickel plated items and aluminium items can be machine processed using special procedures only. Items containing iron, and soiling containing residual rust must not be placed in the cabinet.
- ▶ Chemical agents can, in certain circumstances, cause damage to the machine. Always follow the recommendations of the chemical agent manufacturer. In case of damage or doubt about compatibility, please contact Miele.
- ▶ Cleaning agents containing chlorine can damage the elastomers of the machine. If the use of cleaning agents containing chlorine is required, a maximum temperature of 75 °C in the “Main wash” programme phases is recommended (see programme chart). Cleaning agents containing chlorine must not be used in machines supplied (ex works) with special oil-resistant elastomers for oil and grease applications.

Warning and Safety instructions

- ▶ Pre-treatments with cleaning or disinfecting agents can create foam, as can certain types of soiling and chemical agents. Foam can have an adverse effect on the cleaning and disinfection result.
- ▶ Processes must be set up such that foam cannot escape from the wash cabinet. It would hinder the correct functioning of the machine.
- ▶ The process used must be monitored on a regular basis by the supervisor to check foaming levels.
- ▶ To avoid the risk of damage to the machine and any accessories used with it caused by chemical agents, soiling and any reaction between the two please read the notes in “Chemical processes and technology”.
- ▶ Even when a process chemical, e.g. cleaning agent, is recommended, the machine manufacturer takes no responsibility for the effect of such process chemicals on the load.
Please note that changes in product formulation, storage conditions, etc. which are not announced by manufacturers of process chemicals may impair the quality of cleaning results.
- ▶ When using process chemicals, always consult the instructions issued by individual manufacturers. Process chemicals must only be used for the purpose they are designed for by the manufacturer to avoid any material damage or the occurrence of very strong chemical reactions (e.g. oxyhydrogen explosion).
- ▶ Always follow the relevant manufacturer's instructions on storage and disposal of chemical agents.
- ▶ Particles $\geq 200 \mu\text{m}$ are removed by the filters in the wash chamber. Smaller particles may find their way into the circulation system.
- ▶ In critical applications where very stringent requirements have to be met, it is strongly recommended that all the relevant factors for the process, such as chemical agents, water quality etc. are discussed with the Miele Application Technology specialists.
- ▶ If the cleaning result is subject to particularly stringent requirements, e.g. in chemical analysis, the operator must carry out regular quality control to ensure that required standards of cleanliness are being achieved.
- ▶ Mobile units, modules and inserts should only be used for the purpose they are designed for.
Hollow instruments must be thoroughly cleaned, internally and externally.
- ▶ Secure small and light items with cover nets or place in a mesh tray for small items, so that they do not block the spray arms.
- ▶ Empty any containers or utensils before loading them.

Warning and Safety instructions

- ▶ The amount of residual solvents and acids on items going into the cabinet should be minimal. There should be no more than a trace of any solvents with a flash point of below 21 °C.
- ▶ Chloride solutions, in particular hydrochloric acid, must not be placed in the cabinet.
- ▶ Ensure that solutions or steam containing chlorides or hydrochloric acid do not come into contact with the stainless steel outer casing of the machine in order to avoid any damage through corrosion.
- ▶ After any plumbing work the water pipework to the machine will need to be vented. If this is not done, components can be damaged.
- ▶ Follow the installation instructions in the operating and installation instructions.

Use of components and accessories

- ▶ Only Miele accessories should be connected to this machine. They must be suitable for the application they are required for. Consult Miele for details on the type of accessories that can be used.
- ▶ Only use Miele mobile units, baskets and inserts with this machine. Using mobile units and inserts made by other manufacturers, or making modifications to Miele accessories can cause unsatisfactory cleaning results, for which Miele cannot be held liable. Any resultant damage would not be covered by the guarantee.
- ▶ Only use process chemicals which have been approved by their manufacturer for the relevant application. The manufacturer of the process chemicals is liable for any negative influences on the material of the load and the machine.

Symbols on the machine

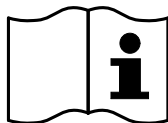

Warning:
Observe the operating instructions!

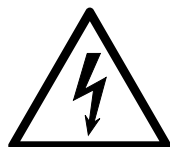

Warning:
Danger of electric shock!



Warning: Hot surfaces:
It can be very hot inside the wash cabinet when the door is opened!

Disposing of your old machine

► Please note that, depending on the application, the old machine may be contaminated with blood and other bodily fluids, pathogens, facultative pathogens or genetically modified material, etc., and must be decontaminated before disposal.

For environmental and safety reasons, dispose of all process chemical residues in accordance with safety regulations and the manufacturer's safety data sheets (wear safety goggles and gloves).

Remove or disable the door so that children cannot become trapped inside. Then make appropriate arrangements for safe disposal of the machine.

For machines with a tank system, the water in the tank must be removed beforehand.

► Before disposal, all personal data saved in the machine must be deleted, e.g. user names.

Main menu

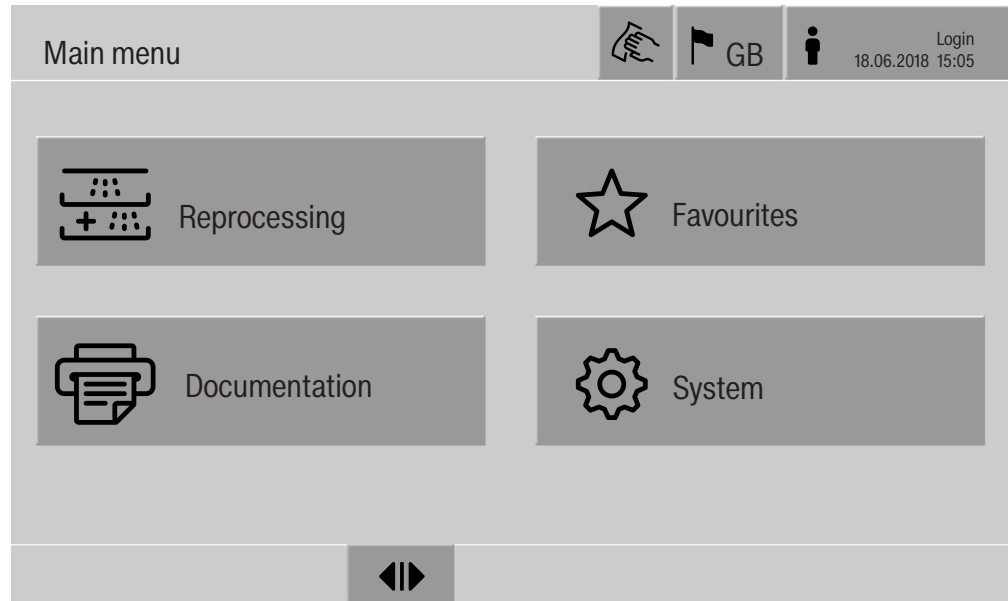

Actions in the Main menu

The main menu of the machine is split into headers and footers and 4 menus. The following actions can be performed using the buttons:

- Lock the display, e.g. for surface disinfection (see “Maintenance, locking machines”)
- Change the display language
- Log a user in and out
- Close popups with messages depending on the user level and the type of message, warning or error message (see “Error messages and instructions”)
- Open the list of active messages (see “Error messages and instructions”)
- Select and start a reprocessing programme depending on the settings in the Programme management menu in the web interface (see “Operation”)
- Call up and start reprocessing programmes stored as Favourites depending on the settings in the System, Manage favourites menu (see “Operation”)
- Print out Reprocessing reports
- Open the System menu to adjust the machine settings depending on the User level (see “System settings”)
- Open and close the infeed door
- Open and close the outfeed door after the end of a programme depending on the Authentication - End of programme setting in the web interface

Changing the display language

Changing the display language has no impact on the set system language. Reports and printouts are issued in the system language.



- Press the  button in the header of the display.

The Select display language menu is displayed.

- Press the button for the language you want.

The machine controls return to the previous menu; the selected language is set.

Press the  button to exit the language selection menu if you do not want to change the set language.

Login

Access to the machine display is restricted to a certain group of users. Every user must be entered in the User management in the web interface (see programming handbook, “User administration”).

Manual login



- Press the  button in the header to open the user login window.
- Enter the user ID and press **OK** to confirm.
- Enter the PIN and press **OK** to confirm.

The functions on the machine display are enabled.

When a user logs in for the first time, they will be prompted to set a new PIN.
If the PIN has expired, this prompt will be displayed for the user. The validity period of the PIN can be set in the web interface under “System, Identification”.

Main menu

Logout

The logged-in user is automatically logged out after 24 hours if no button has been pressed on the display in that time, or if the machine carries out an automatic restart.

The automatic restart can be set in the web interface under “System, Automatic restart”.

Deactivating automatic logout

Automatic logout can be deactivated in the web interface under “System, Identification, Logout”.

Manual logout

A user who is logged in can log out manually, e.g. to protect the machine from access without authorisation.



- Press the  button in the header to log out.

- Confirm the confirmation prompt with Yes.

The functions on the machine display are disabled.

Documentation

The last 200 reprocessing reports saved in the machine controls are shown on the display. The most recent reprocessing report is the first on the list. When the number of saved reprocessing reports exceeds 200, the oldest from the list is deleted.

If no external software for process documentation is connected to the machine, the reprocessing reports can either be printed out using an external printer connected via the network or downloaded to a USB stick.

Printing

Printing out individual reprocessing reports on an external printer:

- Press the  Documentation button.

A list of the reprocessing reports is displayed.

- Press the button in the Print column to activate the required reprocessing reports.

- Press the **OK** button in the footer to start printing.

- Press the button in the Print column again to deactivate the selection.

The reprocessing report is printed out on the external printer.

Downloading

All available reprocessing reports can be downloaded to a USB stick. The USB port is located behind the service cover on the infeed side of the machine.

The USB stick must be FAT-32-formatted and have a minimum capacity of 1 GB.

- Press the  Documentation button.

A list of the reprocessing reports is displayed.



- Press the  button in the footer.

The following message appears on the display:

USB port is being activated. Please wait..

Once the USB port has been activated, the following message appears on the display:

Please insert a FAT32 formatted USB stick with a 1GB minimum capacity into the USB port.

- Open and remove the service cover.
- Open the cover cap on the USB port.
- Plug the USB stick into the USB port and confirm the message with **OK**.

The following messages appear on the display one after the other:

- The USB stick is being tested. Please wait.
- Reprocessing reports are being copied onto USB. This can take several minutes.
- Reprocessing reports copied successfully. Please remove USB.

- Remove the USB stick from the USB port.
- Then confirm the message with **OK**.

The list of reprocessing reports is displayed again.

- Press  to exit the Documentation menu.

The Main menu is shown on the display.

- Place the cover cap on the USB port.
- Fit and close the service cover.

Press  to terminate copying.

Main menu

Opening and closing the door The status of the machine door is shown in the footer of the display.



- ▶▶ The door has been released and can be opened.
- ▶▶ The door is open and can be closed.
- 🔒 The door is locked.
- Press the button with the ▶▶ symbol to open the door.

The door will move up.

- Press the button with the ▶▶ symbol to close the door.

The door will move down.

Risk of crushing

There is a risk of crushing at the bottom of the door when it is closing.

Do not put your hand inside the door when it is moving down to close.

General information

Transfer trolley

A TT 86 transfer trolley is used for transporting load carriers from preparation areas to the machine, and from there to checking and packing tables.

In order to use transfer trolleys of type MF 27/28-1, the machine must be fitted with the conversion kit RFMF 27/28.

Transfer trolleys are supplied with their own operating instructions.

Transfer trolleys of type MF-1 are not permitted for use.

Load carriers

The machine can be fitted with a variety of load carriers, which can be combined with a variety of modules and inserts depending on the type and shape of load items requiring cleaning and disinfection.

Select load carriers and other equipment, e.g. irrigation connectors, which are appropriate for the application.

Information on the individual areas of application can be found on the following pages, as well as in the operating instructions for the load carriers.

Miele offers suitable load carriers for all areas of application defined in "Appropriate use", such as mobile units, modules, inserts and special irrigation connectors. More information can be obtained from Miele.

Series E 9xx load carriers

Load carriers with the designation E 9xx can be used in the machine provided they were manufactured in 2007 or later.

A 857 retrofit kits for the mobile units are available from Miele.

Pictograms for manual programme selection

When you select a programme manually on the machine, you must select the relevant mobile unit first. Pictograms representing the mobile units are shown on the display. The pictograms assigned to the mobile units in the A 5xx model range are listed in the operating instructions for the mobile units.

Mobile unit/module combinations from the A 5xx model range

The pictogram and name of the mobile unit can be found on a strut on the front of the mobile unit. The model shown is the mobile unit without modules inserted.

For different module combinations in the A 500 and A 503 mobile units, several pictograms can be displayed (see operating instructions for the mobile unit).

Fixed mobile units from the A 5xx model range

The pictogram and name of the mobile unit can be found on the front of the mobile unit.

Areas of application

Preparing the load items

Only load items which have been declared by their manufacturer as suitable for machine reprocessing may be processed. The manufacturer's specific reprocessing instructions must be observed.

⚠ Contaminated load items pose a health risk.
Contaminated load items can result in various hazards to health, which can lead to infections, poisoning, injuries or more depending on the type of contamination.
When working with contaminated load items, ensure that all necessary measures are taken to protect personnel.
Wear protective gloves and use appropriate equipment.

- Arrange the load items so that the wash water can access all surfaces. This ensures thorough and proper cleaning.
- Do not place load items inside other items where they may be concealed.
- Do not place load items so close together that cleaning is hampered.
- Load items with internal spaces must be thoroughly cleaned, internally and externally with wash water. Depending on the load items, special irrigation connectors may be required here, e.g. nozzles, irrigation sleeves or adapters.
- Ensure that load items with long, narrow, hollow sections can be flushed through properly before placing them in inserts or connecting them to an irrigation connector.
- Hollow vessels should be inverted and placed in the correct mobile units, modules and inserts to ensure that wash water can flow in and out of them unrestricted.
- Deep-sided load items should be placed at an angle to make sure the wash water runs off them freely.
- Tall, narrow hollow vessels should be placed in the centre of the mobile units if they are not going to be sprayed directly. This ensures the insides of the hollow vessels are more easily accessed by the water jets.
- Take apart any load items which can be dismantled according to the manufacturer's instructions and reprocess the individual parts separately from each other.
- Lightweight load items should be secured with a cover net to prevent them from spinning around in the wash chamber and blocking the spray arms.
- Only reprocess small items and micro components in special inserts, mesh trays with lids or mesh inserts.
- The spray arms must not be blocked by load items which are too tall or which hang down in their path.

- Broken glass can result in serious injury when loading or unloading. Damaged glass load items must not be reprocessed in the machine.
- Nickel and chrome-plated load items, and load items made of aluminium, require special procedures and are not generally suitable for machine reprocessing. Special process conditions are required for these load items.
- With items which are made entirely or partly of plastic, observe the maximum thermal stability for the items and select an appropriate programme or adjust the temperature of the programme.

Preparing the load

 Danger of explosion due to flammable gases. Flammable solvents with a flash point below 21 °C outgas and can generate a flammable mix of gases. Only load the machine with load items which are wetted with traces of solvents at most. Start the reprocessing programme as soon as the machine has been loaded with the wetted load items.

 Risk of damage due to solvents. Solvents with a flash point above 21 °C can damage elastomers and plastics. The machine could leak as a result of this. Only load the machine with load items which are wetted with traces of solvents at most. Start the reprocessing programme as soon as the machine has been loaded with the wetted load items.

 Risk of damage due to corrosion. Chloride solutions, particularly hydrochloric acid, and ferrous materials that can rust or corrode cause corrosion on the stainless steel of the machine and the load carrier. Do not introduce any chloride solutions into the machine. Do not introduce any ferrous materials that can rust or corrode into the machine.

 Risk of infection. Microbiological material, pathogens and facultative pathogens, and genetically modified material can cause infections or environmental damage. Before reprocessing by machine, decide whether the load contaminated in this way needs to be sterilised.

Areas of application

- Empty all load items before loading into the machine, paying particular attention to relevant regulations.
- Remove non-water soluble residues such as paint, adhesives and polymer compounds using appropriate solvents.
- Rinse load items which have been in contact with solvents, chloride solutions or hydrochloric acid thoroughly with water and drain very well. Start the reprocessing programme immediately after loading the machine.
- Scoop nutrient media (agar) out of petri dishes.
- Care should be taken when removing any blood soiling from vessels. Please adhere to local regulations.
- If necessary, rinse the load briefly with water so that larger quantities of soiling are not introduced into the machine.
- Remove all stoppers, corks, labels, sealing wax residue, etc.
- Sort small load items such as stoppers and taps in suitable small-part baskets in order to secure them.

Remove any aids and additives which are difficult to get rid of and contaminate the load in addition to the original soiling in advance. These include grease, paper labels and other labels.

Before starting a programme

Carry out a visual check before starting every programme:

- Is everything correctly loaded/connected for cleaning?
- Can the wash water consistently permeate load items with 2 openings, such as pipettes and viscometers?
- Are the spray arms clean and do they rotate freely?
- Is the filter combination clean?
Remove any coarse soiling and clean the filter combination if necessary.
- Is the mobile unit correctly connected to the water supply?
- Are the removable modules, nozzles, irrigation sleeves and other irrigation connectors correctly connected?
- Are all process chemical containers sufficiently filled?

After the end of a programme

The following must be checked at the end of every programme:

- Are the nozzles and connectors securely held in position in the mobile unit, module or insert?
- Are all lumened load instruments still attached to the appropriate nozzles?
- Have any of the load items on the load carriers moved during reprocessing?

If any of the load items move during reprocessing, this can have a negative effect on the reprocessing result.

Assess whether reprocessing needs to be repeated: for example, if petri dishes have overturned or glass beakers have fallen over.

- Carry out a visual check of the load for cleanliness.
- Can wash water access the insides of load items with 2 openings?
- If the machine is equipped with a drying unit, carry out a visual check of the load for dryness.

Areas of application

Laboratory glassware and utensils

... wide-necked

Load items with wide necks, e.g. glass beakers, wide-necked Erlenmeyer flasks and petri dishes, or cylindrical items, e.g. test tubes, can be cleaned and rinsed inside and out using rotating spray arms. To do this, the load is positioned in inserts and placed in an empty mobile unit with a spray arm.

...narrow-necked

Items with narrow necks, e.g., bottles, narrow-necked Erlenmeyer flasks, round-bottomed flasks, measuring cylinders and pipettes, require special load carriers.

Load carriers are supplied with their own operating instructions.

Please note the following when loading:

- Place petri dishes or similar items in the appropriate insert with the dirty side facing downward.
- Place pipettes with the pointed end facing downwards.
- Arrange inserts at least 3 cm away from the edge of the load carrier.
- Position inserts for test tubes in the centre above the spray arm to leave the corners of the load carrier free.
- Use a cover net to avoid breakages if required.

Programme overview

As the factory default setting, the reprocessing programmes are assigned to the A 503 mobile unit. The following modules can be used in various combinations:

Exceptions to this are the Vials and Pipettes programmes (see table).

In order to use other mobile units, new load carriers must be set up in the web interface under “Load carrier management”. “Load carrier management” is described in the programming manual.

Power levels

The mobile units in the modular loading concept can be fitted with modules in different ways. Depending on the type and number of modules used, different volumes of water and pump speeds are required to achieve a similar wash pressure. The individual reprocessing programmes are therefore available with different power levels. The higher the power level of a reprocessing programme, the higher the volume of water and the pump speed.

The programme structure and the following parameters, which are relevant to performance, are identical in the different power levels:

- The water quality
- The temperature
- The holding time
- The dispensed process chemicals in %
- The drying temperature
- The drying duration

(see appendix: “Power levels/mobile units/module combinations” table)

The standard programmes must be copied and adapted for the APLW 511 3-level mobile unit.

(see appendix: “Power levels of the programmes/Mobile units/Module combinations for the APLW 511” table)

New programmes with the “Max” power level for a load containing 7–9 modules are included in the appendix to the programming manual as programme overviews.

Areas of application

General programmes

Programme	Area of application	Mobile unit
Mini	<ul style="list-style-type: none">- Very short programme for a lightly soiled load and very low final rinse requirements- For a wide range of soiling- Not suitable for denatured residues such as protein- Not suitable for inorganic, acid-soluble residues such as metallic salts- 2 power levels	A 503
Standard	<ul style="list-style-type: none">- Short programme for a lightly soiled load and low final rinse requirements- For a wide range of soiling- Not suitable for denatured residues such as protein- Not suitable for inorganic, acid-soluble residues such as metallic salts- 2 power levels	A 503
Universal	<ul style="list-style-type: none">- Programme for a lightly soiled to moderately soiled load and moderate final rinse requirements- For removing organic residues- Suitable to a limited extent for inorganic, acid-soluble residues, such as metallic salts- 2 power levels	A 503
Intensive	<ul style="list-style-type: none">- Programme for a moderately soiled to heavily soiled load and moderate to high final rinse requirements- For removing organic residues- Suitable to a limited extent for inorganic, acid-soluble residues, such as metallic salts- 2 power levels	A 503

Programmes for specific soiling

Programme	Area of application	Mobile unit
Inorganic	<ul style="list-style-type: none"> - Programme for a lightly soiled to moderately soiled load and moderate to high final rinse requirements - For removing inorganic, acid-soluble residues such as metallic salts - 2 power levels 	A 503
Organic	<ul style="list-style-type: none"> - Programme for a moderately soiled to heavily soiled load and moderate final rinse requirements - For removing concentrated organic residues, e.g. fats, waxes and stubborn dried-on or thermally adhered organic residues - Not suitable for inorganic, acid-soluble residues such as metallic salts - 2 power levels 	A 503
Oil	<ul style="list-style-type: none"> - Programme for a heavily soiled load and moderate final rinse requirements - For removing oils, greases and in some cases waxes - Not suitable for inorganic, acid-soluble residues such as metallic salts - 2 power levels 	A 503
Agar	<ul style="list-style-type: none"> - Programme for a moderately soiled to heavily soiled load and moderate final rinse requirements - For removing agar - 2 power levels 	A 503

Areas of application

Programmes for specific load items

Programme	Area of application	Mobile units
Plastics	<ul style="list-style-type: none">- Programme for lightly soiled to moderately soiled plastics and moderate rinse requirements- For temperature-sensitive laboratory equipment, e.g. plastic bottles that are resistant to temperatures of up to 55 °C- In 2 power levels	A 503
Vials	<ul style="list-style-type: none">- Programme for lightly soiled to moderately soiled small load items and moderate to high rinse requirements- For phials, centrifuge tubes and test tubes- In 2 power levels	A 503 + A 605
Pipettes	<ul style="list-style-type: none">- Programme for lightly soiled to moderately soiled pipettes and moderate to high rinse requirements- For measuring and bulb pipettes- In 3 power levels	A 503 + A 613

Additional programmes

Programme	Area of application	Mobile units
Disin 93/10	<ul style="list-style-type: none"> - Programme for cleaning and thermal disinfection at 93 °C and 10 min holding time in the first programme phase; wash water is only pumped out after the disinfection process - In 2 power levels 	A 503
Rinse cold water	<ul style="list-style-type: none"> - Programme for rinsing the load items with cold water, e.g. to remove: - Heavy soiling - Disinfectant residue <p>or</p> <ul style="list-style-type: none"> - To prevent soiling from drying and becoming encrusted on the load items before the start of a reprocessing programme 	A 503
Rinse demin. water	<ul style="list-style-type: none"> - Programme for rinsing the load items with demineralised water, e.g. to remove: - Heavy soiling - Disinfectant residue <p>or</p> <ul style="list-style-type: none"> - To prevent soiling from drying and becoming encrusted on the load items before the start of a reprocessing programme 	A 503
Drying	<ul style="list-style-type: none"> - Programme for drying temperature-stable load items - Not suitable for heat-sensitive load items 	A 503

Service programme

Programme	Area of application	Mobile units
Empty tank	Programme for emptying the tank, e.g. for long downtimes; the wash chamber must be empty ¹⁾	Zero
Manual disinfection	Programme for emptying the wash chamber when the wash water needs to be decontaminated in the event of a programme cancellation by adding disinfectant (see “Operation, programme cancellation”)	A 503

1) Subject to the settings of the parameter Standby in the web interface under Water intake/ Demineralised water tank, the tank is automatically refilled after the end of the programme (see “System, water inlet machine configuration” in the programming handbook).

Chemical processes and technology

In this section you will find a description of the causes of common chemical reactions which can occur between different types of soiling, chemical agents and the components of the machine, along with their remedies as necessary.

This section is intended as a guide. If unforeseen interactions occur during reprocessing, or if you have any queries on this subject, please seek advice from Miele.

General information	
Problem	Measures
<p>If elastomers (seals and hoses) and plastic components in the machine are damaged, this can lead to, for example, swelling, shrinking, hardening or brittleness of materials, causing tears and cracks to develop. Components cannot function correctly and this generally leads to leaks.</p>	<ul style="list-style-type: none"> - Determine and remedy the cause of the damage. <p>See also the information on “Process chemicals”, “Soiling” and “Reaction between process chemicals and soiling” in this section.</p>
<p>A heavy build-up of foam during the programme sequence will impair the cleaning and rinsing effect on the load. Foam escaping from the wash chamber can cause damage to the machine.</p> <p>When foam develops, the cleaning process is not standardised and can not be validated.</p>	<ul style="list-style-type: none"> - Determine and remedy the cause of the foam build-up - Check the process used regularly to monitor foaming levels <p>See also the information on “Process chemicals”, “Soiling” and “Reaction between process chemicals and soiling” in this section.</p>
<p>Corrosion to stainless steel in the wash chamber and to accessories can give them a different appearance:</p> <ul style="list-style-type: none"> - Rust (red marks/discolouration) - Black marks/discolouration - White marks/discolouration (etched surface) <p>Corrosive pitting can lead to the machine not being water-tight. Depending on the application, corrosion can affect cleaning and rinsing results (laboratory analysis) or cause corrosion to stainless steel load items.</p>	<ul style="list-style-type: none"> - Determine and remedy the cause of corrosion <p>See also the information on “Process chemicals”, “Soiling” and “Reaction between process chemicals and soiling” in this section.</p>

Chemical processes and technology

Process chemicals	
Efficacy	Measures
<p>The ingredients in process chemicals have a strong influence on the longevity and functionality (throughput) of the dispensing system.</p>	<ul style="list-style-type: none"> - Follow the process chemical manufacturer's instructions and recommendations - Carry out regular visual inspections of the dispensing system to check for signs of damage - Check the throughput of the dispensing system regularly - Ensure that the regular cycle of maintenance is observed - Contact Miele for advice
<p>Process chemicals can damage elastomers and plastics in the machine and accessories.</p>	<ul style="list-style-type: none"> - Follow the process chemical manufacturer's instructions and recommendations - Carry out a regular visual check of any exposed elastomers and plastics for damage
<p>Hydrogen peroxide can release large amounts of oxygen.</p>	<ul style="list-style-type: none"> - Use only validated processes - The main wash temperature must be lower than 70 °C when using hydrogen peroxide - Contact Miele for advice
<p>The following process chemicals can cause large amounts of foam to build up:</p> <ul style="list-style-type: none"> - Cleaning agents and rinsing agents containing surfactants <p>Foam can occur:</p> <ul style="list-style-type: none"> - In the programme phase in which the process chemical is dispensed - In the following programme phase if it has been spilt - In the following programme when rinsing agent is dispensed if it has been spilt 	<ul style="list-style-type: none"> - Process parameters in the wash programme, such as dispensing temperature, dosage concentration, etc. must be set to ensure the whole process is foam-free or very low-foaming - Please observe the process chemical manufacturer's instructions
<p>De-foaming agents, especially silicone-based ones, can cause the following:</p> <ul style="list-style-type: none"> - Deposits to build up in the wash chamber - Deposits to build up on the load items - Damage to elastomers and plastics in the machine - Damage to certain plastics in the load items, e.g. polycarbonate, plexiglass, etc. 	<ul style="list-style-type: none"> - De-foaming agents should be used as an exception only; for instance, when they are essential for the process - Clean the wash chamber and accessories periodically without load items and without de-foaming agent using the Organic programme - Contact Miele for advice

Chemical processes and technology

Soiling	
Problem	Measures
<p>The following substances can damage the elastomers in hoses and seals, as well as the plastics in the machine:</p> <ul style="list-style-type: none"> - Oils, waxes, aromatic and unsaturated hydrocarbons - Emollients - Cosmetics, hygiene and skincare products such as creams 	<ul style="list-style-type: none"> - Depending on usage, wipe the lower door seal on the machine periodically with a lint-free cloth or sponge. - Clean the wash chamber and accessories without a load using the Organic programme. - Use the Oil programme or a special programme that dispenses pH-neutral emulsifiers containing surfactants in the pre-rinse.
<p>The following substances can lead to a heavy build-up of foam during washing and rinsing:</p> <ul style="list-style-type: none"> - Some disinfection agents, dishwashing cleaning agents, etc. - Reagents for analysis, e.g. for microtiter plates - Cosmetics, hygiene and skincare products such as shampoos and creams - Active foaming agents such as surfactants 	<ul style="list-style-type: none"> - Thoroughly rinse the load in water beforehand. - Select a cleaning programme with at least one short pre-rinse in cold or hot water. - Depending on the application, use defoaming agents that do not contain silicone oils.
<p>The following substances can cause corrosion to stainless steel in the wash chamber and the accessories:</p> <ul style="list-style-type: none"> - Hydrochloric acid - Other substances containing chlorides such as sodium chloride, etc. - Concentrated sulphuric acid - Chromic acid - Iron particles and shavings 	<ul style="list-style-type: none"> - Thoroughly rinse the load in water beforehand. - Place load items drip-dried into mobile units, modules and inserts and then place these in the wash chamber. - Start a programme as soon as possible after placing them in the wash chamber.

Chemical processes and technology

Reaction between process chemicals and soiling	
Problem	Measures
Natural oils and fats can be emulsified with alkaline process chemicals. This can lead to a heavy build-up of foam.	<ul style="list-style-type: none"> - Use the Oil programme. - Use a special programme that dispenses pH-neutral emulsifiers containing surfactants in the pre-rinse. - Depending on the application, use de-foaming agents that do not contain silicone oils.
Stains containing high protein levels, such as blood, can cause a heavy build-up of foam when processed with alkaline process chemicals.	<ul style="list-style-type: none"> - Select a cleaning programme with at least one short pre-rinse in cold water.
Non-precious metals, such as aluminium, magnesium and zinc, can release hydrogen when processed with very acidic or alkaline process chemicals (oxyhydrogen reaction).	<ul style="list-style-type: none"> - Please observe the process chemical manufacturer's instructions.

Dispensing liquid chemical agents

⚠ Unsuitable process chemicals pose a health risk.
Using unsuitable process chemicals will generally cause an unsatisfactory reprocessing result and can pose a health risk or cause damage to property.
Only use process chemicals designed specifically for use in this machine and follow the manufacturer's instructions on their use.
Please carefully observe any instructions relating to non-toxic residues.

⚠ Process chemicals pose a health risk.
Some process chemicals may be corrosive and irritant.
Observe the relevant safety regulations and safety data sheets issued by the process chemical manufacturers when handling process chemicals.
Take all protective measures required by the process chemical manufacturer, e.g. wear protective goggles and protective gloves.

Dispensing systems

The machine is fitted with 2 dispensing systems for the dosage of liquid cleaning agent and neutralising agent as standard. Up to 4 additional internal dispensing systems can be installed.

The dispensing systems and siphons must be colour-coded. Stickers are supplied in the following colours:

- Blue
- White
- Red
- Green
- Yellow
- Black

Enter the process chemicals used and the relevant colour in the table below if an additional dispensing system has been installed. When containers with process chemicals are connected, the colour code makes it easier to assign the relevant siphon.

Dispensing system	Colour code	Process chemical
1	Blue	
2		
3	Red	
4		
5		
6		

4 external dispensing systems can be connected instead of the 4 optional internal dispensing systems.

If a dispensing system is to dispense different process chemicals, the chemicals must be changed by the Miele Customer Service Department or an authorised technician.

Containers for process chemicals

The drawer for containers with process chemicals is located behind the service panel. There is enough space in the drawer for 4 containers with a 10 l capacity.

Additional containers must be placed outside the machine.

The drawer is equipped with supports. The supports ensure that the containers are slightly inclined. The containers must sit on the supports in such a way that the siphon is located on the lower side.

Always place the 4 containers in the drawer, even if fewer process chemicals are required. This will prevent the containers from falling over when the drawer is opened or closed.

Dispensing liquid chemical agents

Filling containers with process chemicals

Fill the containers for process chemicals or replace them with a full container if a corresponding message is displayed, e.g. Fill container for dispensing system 1.

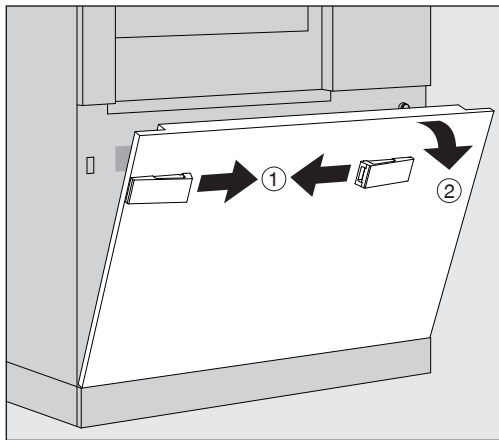

- Unlock the service panel on the machine ①.
- Tilt the service panel forwards ②, lift it up and lift it out of its lower brackets.

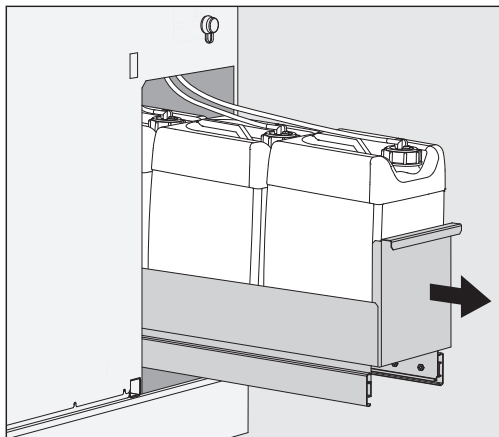

- Pull out the drawer with the containers for liquid process chemicals.
- Take the corresponding container out of the drawer.
- Unscrew and remove the suction lance.
- Fill the process container with the required process chemical and replace it with a new container.

Observe the colour code of the dispensing system and the suction lance to ensure that the process chemicals do not get mixed up.

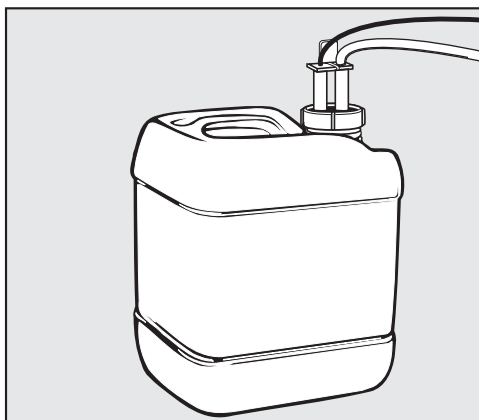

- Push the suction lance into the neck of the container and screw it into place.
- Place the container in the drawer.

The suction lance must be located on the lower side of the support.

- Push the drawer into the machine.
- Insert the service panel into the lower brackets of the machine and press on it.
- Lock the service panel.
- Acknowledge the message Fill container for dispensing system "x" with the **OK** button.

Each time a container is filled or replaced, the Fill dispensing system function must be carried out to remove any air from the dispensing system.

The function can only be carried out if there is no load carrier in the wash cabinet.

Filling the dispensing system

A dispensing system must be filled when:

- The corresponding container has been filled or replaced with a new one
- The process chemicals have been changed

A dispensing system can only be vented when there is no load carrier in the wash chamber.

- Open the System menu.
- Open the Machine functions option.
- Open the Fill dispensing system option.
- Press the button for the corresponding dispensing system, e.g. DOS 1.

The dispensing system will be filled.

Switching the machine on and off

The **I/O** power switch disconnects the machine from the power supply. The switch is located above the display.

- Press the **I** power switch to switch the machine on.

Once the boot process has finished, the machine is ready for operation.

- Press the **O** power switch to switch the machine off.

The machine controls are shut down and the machine is disconnected from the power supply.

Loading the wash chamber

The load carrier is pushed into the machine wash chamber from the infeed side.

- Press the button **◀▶** to open the door on the infeed side.
- Push the load carrier of the transfer trolley into the wash chamber of the machine.

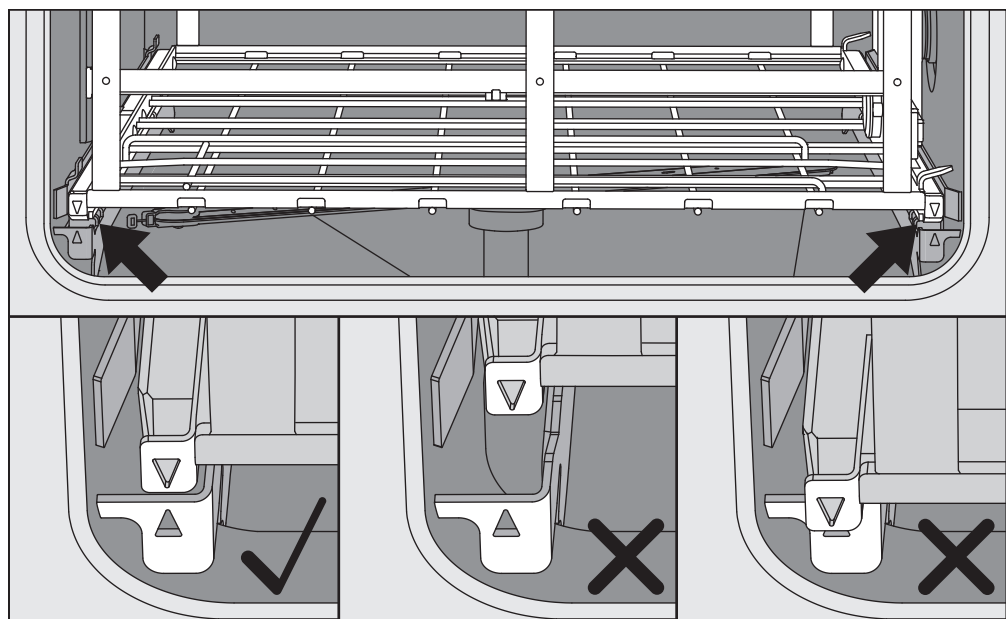

The markings on the load carrier ▼ and in the wash chamber ▲ must line up correctly.

- Press the button **▶◀** to close the machine door.

Selecting a programme

The reprocessing programmes are assigned to certain load carriers. Therefore, a load carrier must be selected first with the help of a pictogram.

Selecting a load carrier

- Press the  Reprocessing button.

The menu for selecting the load carrier via a pictogram is displayed.

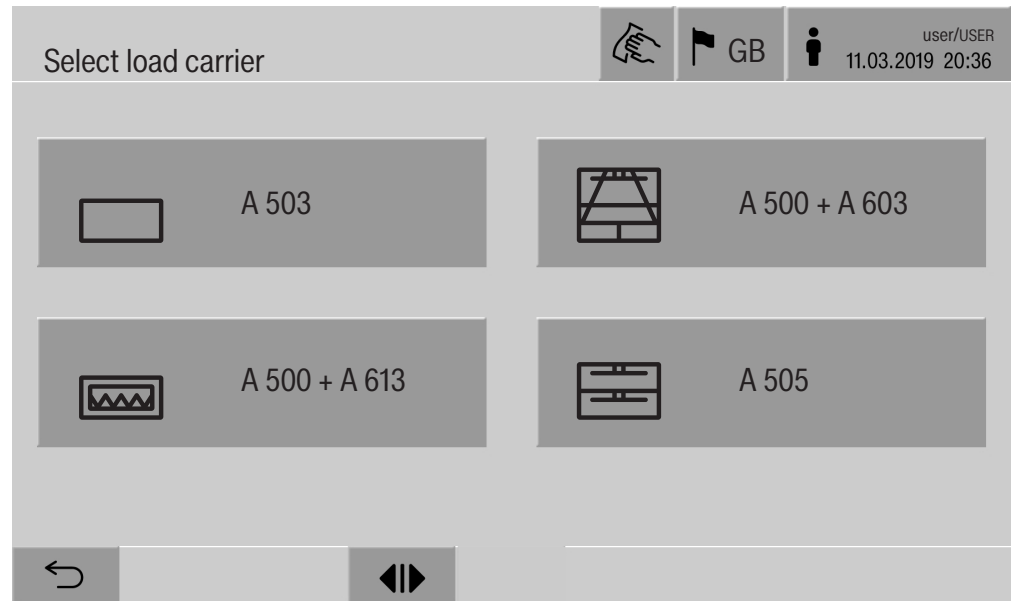

If more than 4 load carriers are available, you will be able to scroll through several pages in the selection menu.

- Press the button for the required load carrier, e.g.  A 503.

The pictogram of the selected load carrier is displayed in the header, e.g.  Reprocessing.



The reprocessing programmes which can be selected are listed.

- Press the button for the required reprocessing programme.

The programme start screen is displayed.

Operation

Selecting programmes from Favourites

If reprocessing programmes have been defined in the  System, Manage favourites menu, the programme can be selected using the  Favourites button.

- Press the  Favourites button.

The Select load carrier menu is displayed.

- Press the button for the required load carrier, e.g.  A 503.

The pictogram of the selected load carrier is displayed in the header, e.g.  Favourites.

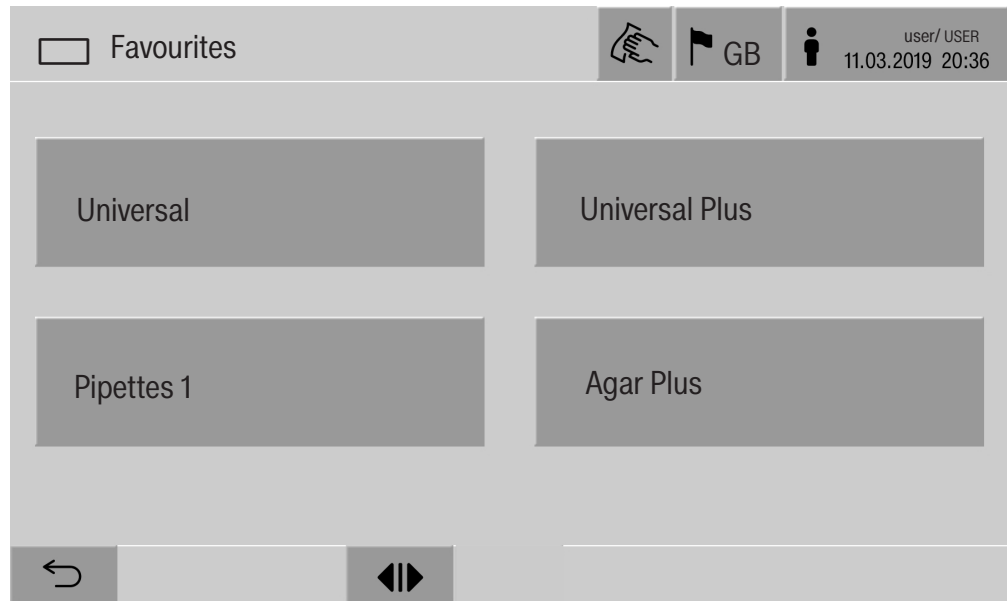

The reprocessing programme defined as a favourite is displayed; Universal in this example.

- Press the button for the required reprocessing programme.

The programme start screen is displayed.

Starting the programme

Check in the display header whether the right reprocessing programme is displayed for the load carrier. With the ↶ button, you can open the menu for selecting the reprocessing programmes if you wish to choose a different reprocessing programme.

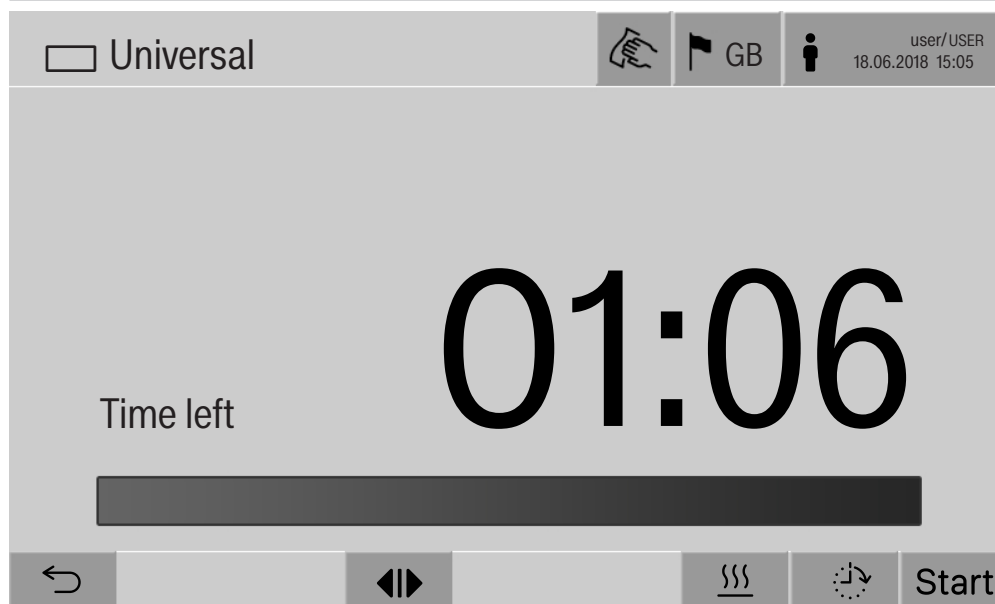

After selecting a programme, the time left for the chosen reprocessing programme is displayed. If the Display time left parameter is not activated in the web interface, the display switches to the already elapsed Duration of the reprocessing programme after programme start.

- Press the start button.

The reprocessing programme runs.

It is only possible to start a reprocessing programme when the machine doors are closed and there are no fault messages.

If the ⊗ symbol is displayed in the footer, you must work through the list of active messages first (see “Fault messages and instructions”).

Programme sequence

The programme will run automatically once it has been started. You can find detailed information about the programme sequence and the programme parameters on the machine display (see “Machine description”, “Control elements on the display”).

End of programme

After the programme has ended, the following is displayed:

- The Cycle number

- The time elapsed since the end of the programme
- The Result of the reprocessing process
- The message Programme finished

The progress bar changes from white to green.

The wash chamber lighting can be switched on automatically depending on the pre-setting.

labelling="Section-Header">**Cancelling a programme**

A reprocessing programme can be cancelled at any time. The wash water is drained, then the door on the infeed side is released.

- Press the stop button.

A confirmation prompt is displayed:
Cancel programme?.

- Confirm the confirmation prompt with Yes.

Once the water has finished draining, the following message will appear on the display:

Programme cancelled.

The progress bar is red and the following error message is displayed:
Programme aborted by user

Once the error message has been acknowledged, the programme can be restarted.

labelling="Section-Header">**Programme cancellation with manual disinfection**

For programmes with the Drainage after disinfection parameter activated, additional work steps may be necessary for programme cancellation. If the thermal disinfection has not been performed, the wash water must be manually decontaminated.

labelling="Section-Header">**Manual programme cancellation**

During the first programme phase:

- Press the stop button and confirm the Cancel programme? safety prompt with Yes.

The error message Programme aborted by user is displayed.

There is stationary wash water in the wash chamber which is not being drained.

labelling="Section-Header">**Programme cancellation due to a fault**

If the programme is cancelled during the first programme phase due to a fault, the wash water will not be drained away. The necessary actions to be taken in such cases are described under “Manual disinfection”.

Manual disinfection ■ Acknowledge the error message in the list with **OK**.

- Acknowledge the programme cancellation with **OK**.

The message Please unload is shown in the programme sequence display.

- Open the door on the infeed side.
- Decontaminate the wash water by adding the disinfectant.
- Close the infeed side door.
- Select the load carrier.
- Select and start the programme Manual disinfection from the list of programmes associated with the load carrier.

The wash water is pumped out and another error message is displayed.

- Acknowledge the error message in the list with **OK**.

The door of the infeed side can be opened.

Delay start

The start of a programme can be delayed, for example, to benefit from economy rates of electricity at night. The delay start period can be set to the exact minute.

If soiling is left to dry on the load for longer, the reprocessing result can be adversely affected. There is also a higher risk of corrosion for stainless-steel load items.

- To configure a delay start, select the  button in the footer.
- Enter the Start time with the on-screen keyboard and press **OK** to confirm.

The reprocessing programme starts automatically at the set time.

The automatic programme start can be cancelled at any time. To do this, press the stop button in the footer. A confirmation prompt is displayed: .Cancel delay start? Once the confirmation prompt has been confirmed, the reprocessing programme can be started manually.

Network connection

The machine can be integrated into an internal network via an Ethernet interface. Only the systems required for machine access via a web interface and for the documentation of reprocessing results (e.g. a PC on which the documentation software is installed) may be operated on this network. A standard network cable – CAT5 Ethernet cable or higher – is required for the connection.

The Customer Service Department must connect the network cable to the interface.

 Unauthorised access poses a health risk.

Settings in the machine, e.g. parameters for disinfection or the dispensing of process chemicals, may be changed as a result of unauthorised access via the network.

Under no circumstances should it be possible to access the machine via the Internet or other public or unsecured networks, either directly or indirectly (e.g. using port forwarding)!

The IP addresses from 192.168.10.1 to 192.168.10.255 are reserved for the Customer Service Department. They must never be set in the internal network.

1. The machine should be operated only in a separate network segment which meets one of the following requirements:
 - It is physically separated from other network segments
 - Access to the segment is restricted by a firewall or a router which has been configured accordingly
2. Limit access to this separate network segment to persons requiring access in the course of their work.
3. Use strong passwords to protect access to systems that are connected to the machine.
4. Configure the Ethernet interface.

Network protocols

The machine supports communication via the following network protocols:

Network protocols	Description	Port
DHCPv4	Assigning dynamic IPv4 addresses	68/UDP
DHCPv6	Assigning dynamic IPv6 addresses	546/UDP
HTTPS	Web interface for configuring the machine	443/TCP

The ICMPv4 and ICMPv6 protocols are also supported.

Process documentation

The reprocessing processes in the machine can be documented via external process documentation software or an internal or external printer.

Please note the following when connecting a printer or PC:

- Only PCs or printers which are certified in accordance with EN/IEC 60950 may be used.
- The size of the printer or PC must be taken into account when installing the machine
- An extension lead for the Ethernet interface may not be longer than 100 m

Please contact the machine manufacturer for further information on suitable printers and software.
--

System settings

System

The  System menu contains the following functions:



The sub-menus are opened with the buttons. The functions in the sub-menus are described on the following pages.

Network connections

The Network connections menu contains network configuration and user login functions. Once the Network connections menu has been opened, the following menu will appear on the display:

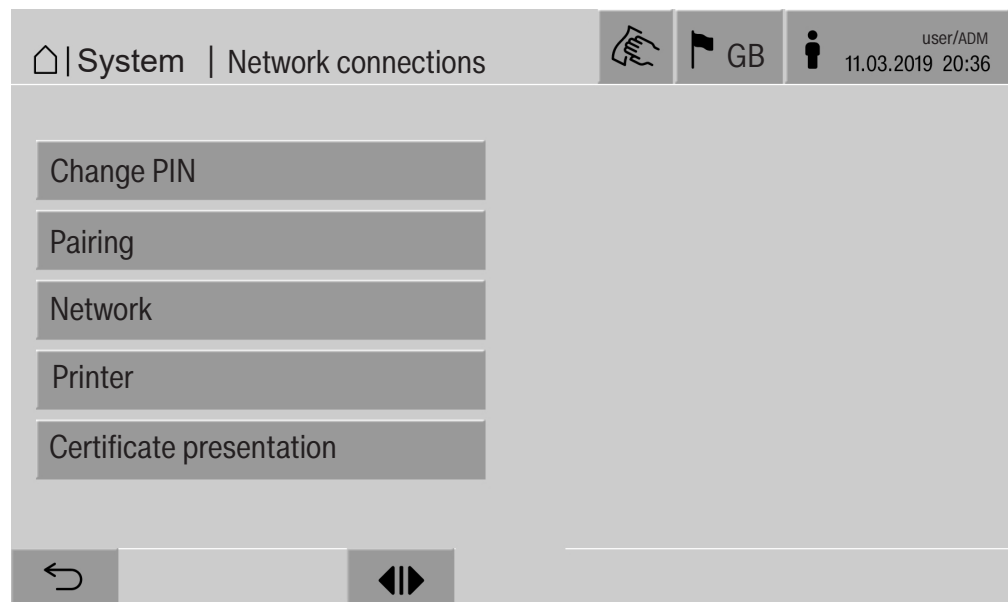

The sub-menus are opened with the buttons.

Changing the PIN A user can change their PIN at any time.

The minimum length of the PIN depends on the user level:

- Operator 4 digits
- Technician 8 digits
- Administrator 10 digits

The PIN must contain numbers as well as uppercase and lowercase letters. A–Z, a–z, 0–9, hyphens “-” and underscores “_” can be used. It is not permitted to use:

- The same character more than three times in succession, e.g. 11112345
- Numbers at the end of a password, e.g. User_123
- One of the last ten passwords again

- Press the Change PIN button.

Entry prompts are given to change the PIN. The buttons next to the parameters open the on-screen keyboard.

- Enter the old PIN and then the new PIN twice and press **OK** to confirm.

The new PIN is applied in the User management in the web interface. It is not visible there. If a user has forgotten their PIN, they can reset it in the User management.

The PIN for the Administrator user level can only be reset by the Customer Service Department.

System settings

Pairing

If the machine is connected to a network, external applications can access the machine controls, e.g. software for Process documentation or the web interface (Web interface). When the machine is connected for the first time, Pairing must be carried out between the machine and the external application.

A maximum of 9 external applications can be connected to the machine at the same time. An old connection must be disconnected before another new pairing request can be confirmed.

- Press the **Pairing** button.

A menu is displayed which lists active connections and open requests with the date and time. Symbols are used to indicate the status of a pairing request:

Symbol	Function
✓	Pairing confirmed
↔	Disconnect pairing
><	Pairing requested

Confirm pairing

A pairing request must be confirmed for an external application to make access to the machine possible. A 6 to 10-digit Pairing PIN is assigned for this.

- Press the **|><|** button.

The on-screen keyboard is displayed for entering the Pairing PIN.

- Enter the Pairing PIN and press **OK** to confirm.

This Pairing PIN must be entered in the external application to complete the pairing process.

Disconnecting or rejecting pairing

An existing pairing connection can be disconnected and a pairing request can be rejected at any time.

- Press the **↔** button next to the corresponding application.

The pairing connection is disconnected and the line for the corresponding application is deleted from the menu.

Assign write permissions

If you need to download data or configure the machine settings using the web interface, the logged-in user must possess the appropriate write permissions. Once a user has requested write permissions, the following message is shown on the display:

i Allow connection with write authorisation? ...
Date/Time

The request for write permissions can be granted by the Login on the machine or rejected with the ↵ button.

- Press the Login button to assign write permissions.

The on-screen keyboard is displayed for login.

When the machine is being accessed externally with write permissions, the following message is shown on the display:

Connection with write authorisation active ...

The write permissions can be revoked. To do this, proceed as follows:

- Press the ↵ button.

The on-screen keyboard is displayed for login. The login removes all write permissions, and when you select the ↵ button, the write connection remains intact.

Write permissions can be deleted by the logged-in user in the web interface. In this case, it is not necessary to log into the machine display.

System settings

Setting the network

The Ethernet connection is configured in the **Network** menu. The network can be configured on the machine display or using the web interface. Before the machine is connected for the first time, e.g. to a network printer, the network must be configured on the machine display. To set the printer up in the web interface, see the programming manual.

You will receive the information required for configuring the network from your network administrator.

- Press the **Network** button.

The network configuration parameters are displayed. The buttons next to the parameters open the on-screen keyboard.

- Enter the required values for each parameter and press **OK** to confirm.

Use the IP address or the Host name to address the machine in the network.

Manual entry

Parameter	Report version IPv4	Report version IPv6
Active	Active	Active
DHCP	Inactive	Inactive
IP address	Input field	Input field
Subnet mask	Input field	–
Prefix length	–	Input field
Host name	Input field	Input field
Standard gateway	Input field	Input field

Automatic assignment

Parameter	Report version IPv4	Report version IPv6
Active	–	–
DHCP	Active	Active
IP address	–	–
Subnet mask	–	–
Prefix length	–	–
Host name	Input field	Input field
Standard gateway	–	–

Configuring the printer

A connected printer can be set up using the display or the web interface. To set the printer up in the web interface, see the programming handbook.

- Press the **Printer** button.
- Press the button next to the **Type** parameter.

The display shows a menu with the available printer options.
Please note:

- Activate the required printer with the button next to the model designation.

The bar in the button of the activated printer is displayed in white.

- Exit the menu with the **↶** button.

You must enter the corresponding IP address of the selected network printer.

- Press the button next to the **IP address** parameter.

The on-screen keyboard is displayed for entering the IP address.

- Enter the IP address and press **OK** to confirm.

The **Direct print-out** parameter determines whether a reprocessing report is to be transferred to the connected printer and printed out immediately at the end of the programme. In addition to being printed out directly, the reprocessing report is also saved in the machine controls. You can print out additional copies of a reprocessing report using the **Documentation** button in the **Main** menu.

- Press the button next to the **Direct print-out** parameter to activate the option to print out directly.

The bar in the button is displayed in white.

System settings

Certificate presentation

The machine has a self-signed TLS certificate in the x.509 standard. The certificate is used whenever you access the machine via the network with a web browser. It is also used to authenticate secure communication with the machine, e.g. in conjunction with software for process documentation.

In some cases, a security notification will be displayed in the web browser due to a self-signed TLS certificate not being recognized.

Comparing certificates

The fingerprint and the validity period of the certificate can be displayed on the machine. The data can be compared with the data sent to the web browser.

- Press the Certificate presentation button.

The following data is displayed.

- Certificate SHA1
- Certificate SHA256
- Valid from
- Valid until

Machine functions

The Machine functions menu contains service functions, e.g. for dispensing systems and for built-in tanks. Once the Machine functions menu has been opened, the following menu will appear on the display:

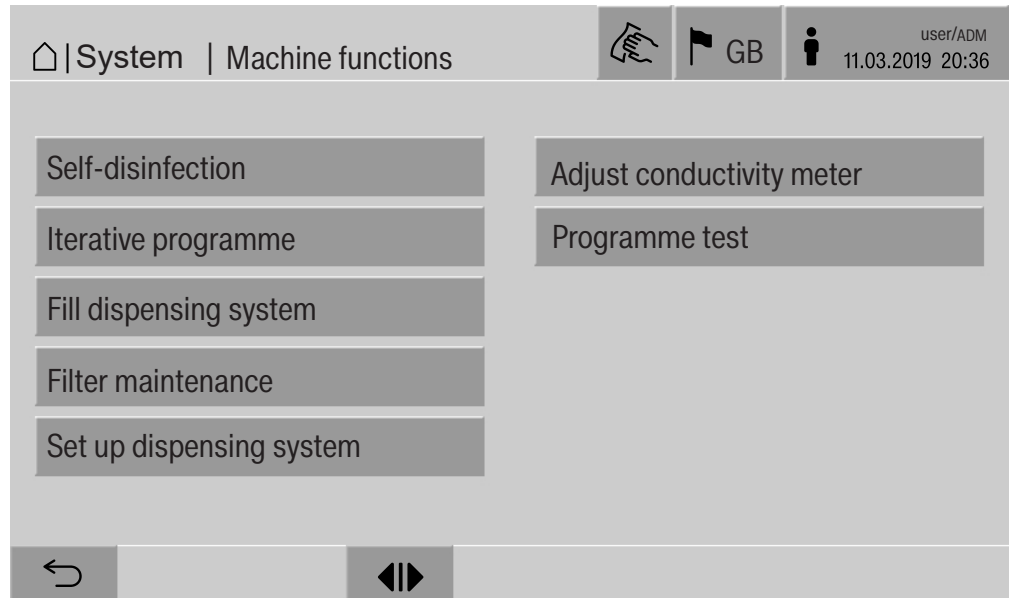

The individual functions are started with the buttons.

Automatic system test

During the automatic system test, the Self-disinfection of the built-in tanks (if fitted) is performed at a specified time.

For the automatic system test, the following conditions must be met:

- The machine is switched on
- The wash cabinet is empty
- The machine door is closed
- No continuous programme is active
- No write permissions have been assigned to enable access via the web interface

The automatic system test can be turned off in the web interface (see "System, machine configuration, automatic system test" in the programming manual).

System settings

Carrying out self-disinfection (optional)

This button is only displayed when the machine is fitted with an internal tank. The machine's internal tanks are disinfected via Self-disinfection during the automatic system test.

Every self-disinfection carried out is assigned a cycle number and a reprocessing report for documentation purposes.

If documentation is not required, the function can be deactivated by the Miele Customer Service Department.

If the automatic self-disinfection of the internal tanks was not completed without faults, this function can be started manually.

Self-disinfection can only be carried out if there is no load carrier in the wash cabinet.

- Press the Self-disinfection button.

The steps required for self-disinfection run automatically. Once self-disinfection has finished, a message will appear on the display:

Self-disinfection completed

or

Self-disinfection failed

- Press **OK** to confirm the message.

If the self-disinfection is not repeated successfully, contact the Customer Service Department.

You can cancel self-disinfection with the stop button in the footer. The Cancel self-disinfection? confirmation prompt is displayed. Self-disinfection is cancelled with Yes and continued with No.

Starting the continuous programme

A repeated programme start can be defined for a reprocessing programme in the Iterative programme menu. This function can be used for wash-related trials, e.g. material tests, or for periodic decontamination in the event of long downtimes.

- Press the Iterative programme button.

The display shows the available load carriers.

- Press the button for the required load carrier.

The available reprocessing programmes are displayed.

- Press the button for the required reprocessing programme.

The parameters for defining the continuous programme are displayed. The buttons next to the parameters open the on-screen keyboard. The limits for the selected parameters are displayed in the header of the on-screen keyboard.

Parameters for the continuous programme

Parameter	Definition
Programme cycles	Number of programme cycles for the continuous programme
Pause between programme cycles	Period between the end of the programme and the subsequent programme start
Door delay	Period between the end of the programme and the opening of the machine door
Open door for	Period between the opening and closing of the machine door
Door selection	Choice of machine door which is opened after a programme run

- Enter the required values for each parameter.
- Press the start button in the footer to start the continuous programme.

The message Iterative programme: Warning! Door opens and closes automatically. will appear on the display. Press **OK** to start the continuous programme and ↵ to cancel the procedure.

Once it has been started, the reprocessing programme is repeated until the set programme runs are reached.

You can cancel the continuous programme at any time with the stop button.

System settings

Filling the dispensing system

The Fill dispensing system function is used to prime the relevant dispensing system. The function must be carried out after a container for process chemicals is filled or replaced with a full container.

The function can only be carried out if there is no load carrier in the wash chamber.

- Press the Fill dispensing system button.
- Press the button for the required dispensing system, e.g. DOS 1.

The individual steps are shown on the display during the process. Once the process has finished, a message will appear on the display: Dispensing system DOS 1 filled.

or

Dispensing system DOS 1 not filled. Repeat Fill dispensing system..

- Press **OK** to confirm the message.

If the process of filling a dispensing system is not repeated successfully, contact the Customer Service Department.

Filter maintenance

If the machine is equipped with a drying unit, the coarse and fine filters inside the drying unit must be replaced by the Miele Customer Service Department at regular intervals.

You can read off the operating times and the times left for the individual filters in the Filter maintenance menu.

Dispensing system setup

The Set up dispensing system is used to adjust the dispensing systems. It must be performed if:

- The connected process chemical has been changed (different viscosity)
- A new dispenser pump or flow sensor has been fitted
- The dispensing system needs to be checked, e.g. in the event of qualification, requalification or a periodic check

During setup, the dispenser pump is energised for a defined number of impulses. At the same time, the controller counts the number of impulses picked up by the flow sensor. Once the measured volume has been entered into the controller, this calculates the conversion factors for the throughput of the dispenser pump in $\mu\text{l}/\text{imp.}$ and the impulse rate of the flow sensor in $\mu\text{l}/\text{imp.}$

Setup

A dispensing system can only be set up when there is no load carrier in the wash cabinet.

In order to determine the exact throughput for the dispensing pump and the impulse rate of the flow sensor, 2 measuring cylinders are required:

- 1 x 1000 ml
- 1 x 100 ml
- Place the suction lance of the dispensing system into a 500–1000 ml measuring cylinder.
- Fill up the measuring cylinder with the process chemical to be dispensed.
- Fill up the 100 ml measuring cylinder with the process chemical to be dispensed.

Before the dispensing system is set up, the dispensing systems must be vented.

- Press the **Fill dispensing system** button.
- Press the button for the required dispensing system, e.g. DOS 1.

Once the process has finished:

- Press **OK** to confirm the message.
- Fill up the 500–1000 ml measuring cylinder with the process chemical to be dispensed from the 100 ml measuring cylinder and either mark or make a note of the fill level.
- Fill up the 100 ml measuring cylinder all the way with the process chemical to be dispensed.
- Press the **Set up dispensing system** button.
- Press the button for the required dispensing system, e.g. DOS 1.

System settings

The following message will be displayed:

Starting setup for the dispensing system ... Preparing the dispensing system.

- Confirm the message in the display with **OK**.

The dispensed quantity will then be measured.

The process steps will be displayed, e.g. Dispenser pump active.

When the measurement is complete, the on-screen keyboard opens.

The value set previously is shown.

- Fill up the 500–1000 ml measuring cylinder up to the original fill level with the process chemical from the 100 ml measuring cylinder.
- Take a reading of the volume needed to fill the cylinder up from the 100 ml measuring cylinder.
- Enter this value into the on-screen keyboard and confirm with **OK**.

The measurement results for the conversion factors are displayed,

e.g.:

Conversion factor DOS 1:

old ... $\mu\text{l}/\text{Imp}$ new ... $\mu\text{l}/\text{Imp}$

Conversion factor flow sensor 1:

old ... $\mu\text{l}/\text{Imp}$ new ... $\mu\text{l}/\text{Imp}$

Accept new values?

Select **OK** to apply the new conversion factors to the controller and **↵** to retain the old conversion factors. The Set up dispensing system menu will appear again in the display.

Contact the Customer Service Department for the Set up dispensing system if the machine's dispensing systems are not fitted with suction lances.

Calibrating the conductivity meter

When particularly high demands are placed on the cleaning and final rinse result, e.g. in chemical analysis, the conductivity meter can be adjusted with the Adjust conductivity meter function. The measuring system is adjusted in the conductivity measuring range from demineralised water to cold water.

Adjustment of the conductivity meter can only be carried out if there is no load carrier in the wash chamber.

The wash chamber should be rinsed with demineralised water in order to avoid excessively high readings due to the transfer of alkaline solution.

- Press the Adjust conductivity meter button.

The measurement for demineralised water is performed.

In the display, the message Please wait... and the current process step is shown, e.g. Measurement active.

Once the measurement is complete, the Demin. water conductivity: Actual is shown along with the input screen for the manually determined value.

The door of the infeed side is released for the manual measurement.

- Open the door and perform the manual conductivity measurement.
- Close the door.
- Select the button next to the Demin. water conductivity: New parameter to open the on-screen keyboard.
- Enter the measured value into the on-screen keyboard and confirm with **OK**.

Readings with decimal places must be mathematically rounded.

- Press the **OK** button.

The measurement is performed for cold water.

- Perform the same work steps as for the demineralised water if the Cold water conductivity: Actual message is displayed.

The input values for Conductivity ... new are applied in the control system.

The Machine functions is shown again in the display.

Adjustment of the conductivity meter can be cancelled using the stop button in the footer. The message Adjustment of conductivity meter unsuccessful. Please repeat. will appear on the display.

System settings

Carrying out a programme test

Newly created or modified reprocessing programmes can be checked with the Programme test. The programme can only be enabled with the Programme test parameter if a reprocessing programme has run through the Checked without any faults (see programming handbook, “Programme administration”).

The Programme test can be used to check the cleaning performance. During the programme test, the programme sequence stops after each programme phase and the door on the infeed side can be opened so that a sample can be taken.

When you open the door between 2 programme blocks, please be aware of the following sources of danger:

- Risk of burning and scalding after high-temperature programme blocks
- Risk of contact with corrosive substances after programme blocks that dispense process chemicals
- Risk of inhaling toxic vapours after programme blocks that use disinfectants

Steam that escapes from the machine after high-temperature phases can trigger a false alarm in smoke detectors.

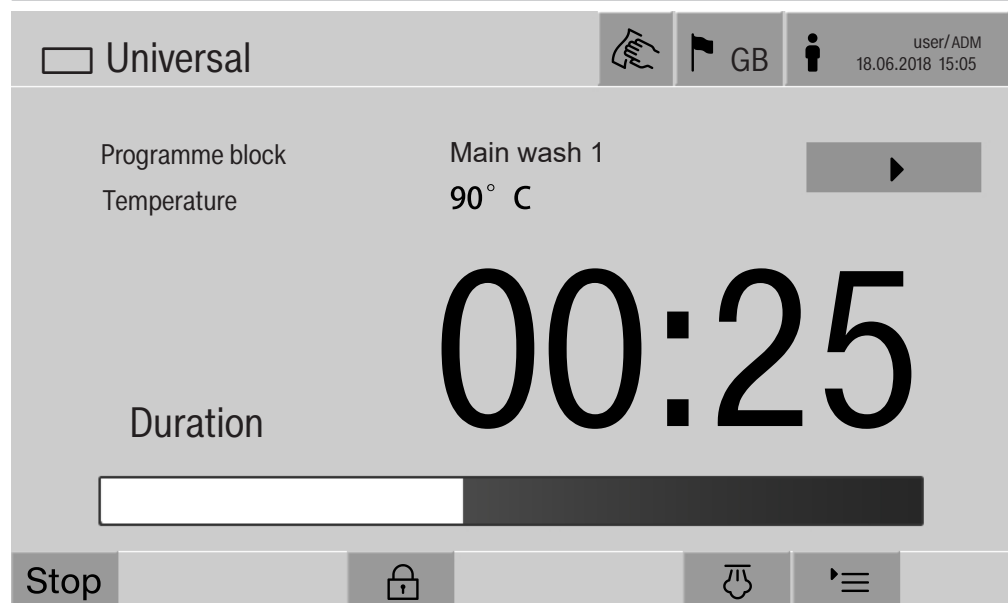

After the reprocessing programme has started, an additional ► button is displayed next to the programme block. The ► button has two functions:

- Continue the reprocessing programme without opening the door
- Skip the next programme block

Sampling example

- Press the Programme test button.

The display shows the available load carrier options.

- Press the button for the required load carrier.

The available reprocessing programmes are displayed.

- Press the button for the required reprocessing programme.

The following message will appear on the display:

Programme test: Skip programme block with ►. Door can be opened at end of each programme block..

- Press **OK** to confirm the message.

The programme start screen is displayed.

- Press the start button.

The ► button is displayed – the start of the reprocessing programme is delayed.

Before the water intake, the relevant programme phases displayed can be skipped by pressing the ► button.

After each programme block, the following message will appear on the display before the wash water is drained:

Programme test: Door can be opened to take sample..

- Press **OK** to confirm the message.

The ◀▶ and ▶ buttons are enabled.

- To take a sample, press the ◀▶ buttons to open the door.

- Once you have taken the sample, press the ▶◀ button to close the door.

The following message will appear on the display:

Continue programme test? To continue, press OK. To open the door again, press ↶..

- Press **OK** to confirm the message.

The wash water is drained and the next programme block begins.

If a sample does not need to be taken after a programme block:

- Press the ▶ button.

The wash water is drained and the next programme block begins.

You can skip each programme block when it begins by pressing the ▶ button.

Restarting

The Restart function shuts down the machine controls and then reboots them. This Restart can be used, for example, when you get the prompt Switch machine off and on when you are troubleshooting.

- Press the Restart button.

The Restart? confirmation prompt is displayed. Press **OK** to restart or ↵ to cancel the process.

Opening the data plate

The following information is listed in the Data plate menu:

- Machine type
- Machine name
- Commissioning date
- Fabrication number
- Fabrication index
- Machine type
- Material number
- Software version

In addition to the Machine name parameter, an individual name can be entered for the machine.

- Press the button next to the Machine name parameter.

The on-screen keyboard is displayed for entering the machine name.

- Enter the name for the machine and press **OK** to confirm.

The assigned machine name is used:

- In the web interface
- In reprocessing reports
- In error reports
- In data transferred to software for process documentation

Managing favourites

You can define your 4 most commonly used programmes as favourites in the Manage favourites menu.

If the Automatic programme allocation is not activated:

After the  Reprocessing button has been pressed, all reprocessing programmes assigned to the load carrier are displayed.

If you select the reprocessing programme via the ☆ Favourites button instead, only the 4 reprocessing programmes defined in the Manage favourites menu are displayed.

If none of the 4 favourites is assigned to the load carrier as a reprocessing programme, the following message will appear on the display:

No Favourites available for current load carrier.

To define favourites:

- Press the Manage favourites button.

4 buttons are displayed for the favourites.

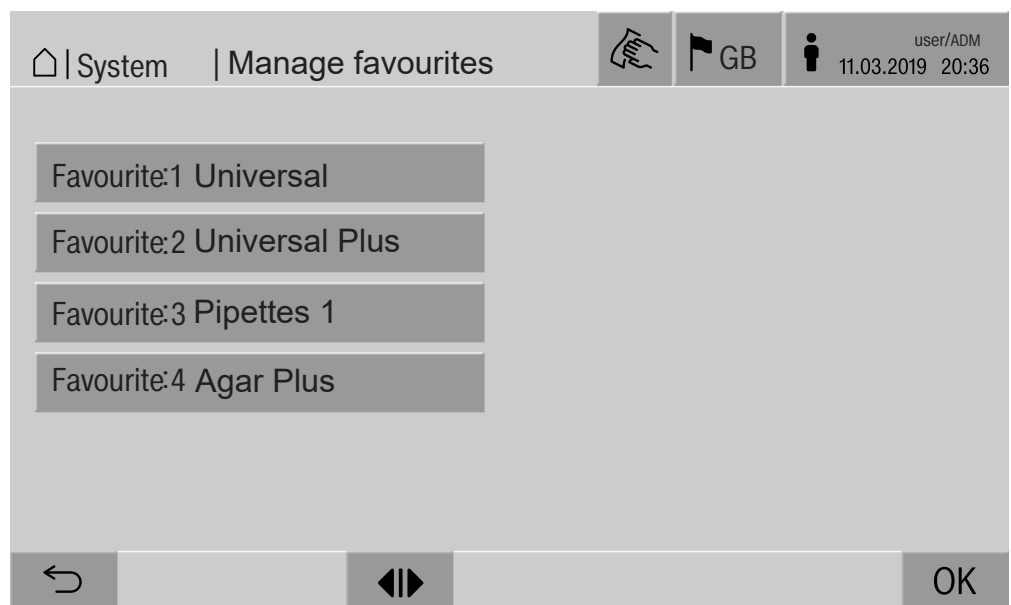

- Press the Favourite 1 button.

The list of reprocessing programmes is displayed.

- Press the button for the required reprocessing programme; Universal in this example.

The name of the reprocessing programme is displayed in the Favourite 1 button.

Define favourites 2–4 in the same way.

- Press **OK** to exit the menu.

Periodic checks

This machine should be inspected in accordance with local and national safety regulations **after every 2000 operating hours, or every 12 months** by a Miele approved service technician.

Maintenance covers the following points and functional checks:

- Electrical safety check compliant with national rules and regulations (e.g. VDE 0701, VDE 0702 in Germany)
- Door mechanism and door seal
- Any screw connections and connectors inside the wash cabinet
- Water inlet and drainage
- Internal and external dispensing systems
- Spray arms
- Filter combination
- Sump including drain pump and drain valve
- Wash mechanism/wash pressure
- All mobile units, modules and inserts (charged separately)
- Visual inspection and functional check of components
- A thermo-electric check
- Seals will be tested for water tightness
- Safety testing of all relevant measuring systems
- Safety features

and where applicable:

- Steam condenser
- Drying unit
- Conductivity monitoring
- Built-in printer

External documentation software and the computer network will not be tested by the Miele Customer Service Department.

Routine checks

Before the start of each working day, the user must carry out a number of routine checks. A checklist is supplied with the machine for this purpose.

The following need to be inspected:

- All filters in the wash chamber
- The spray arms in the machine and in any mobile units, modules and baskets
- The wash chamber and the door seal
- The dispensing systems
- The mobile units, baskets, modules and inserts
- The filters in the load carriers

Cleaning the filters in the wash cabinet

The filters in the floor of the wash chamber prevent coarse soiling from coming into contact with the circulation system. Filters can become blocked by soiling. They therefore need to be checked every day and cleaned as necessary.

⚠ Risk of damage due to blocked waterways.

If the filters are not inserted, dirt particles will end up in the machine water circuit. The dirt particles may block the nozzles and valves.

Only start a programme if the filters are inserted.

Check that the filters are positioned correctly when you reinsert them after cleaning.

- Remove large particles of soiling from the surface of the filter.

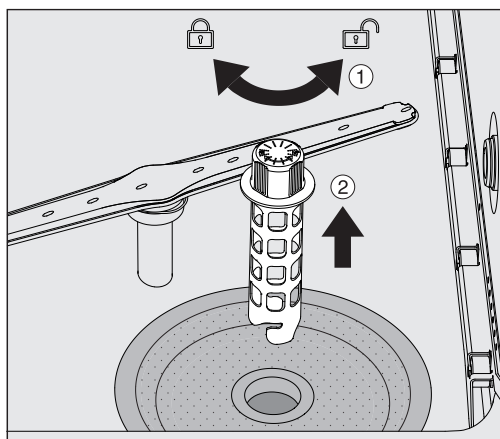

- Turn the holder to the left to release it ① and remove it from the coarse filter ②.
- Rinse the holder under running water, paying particular attention to the perforation at the top end.

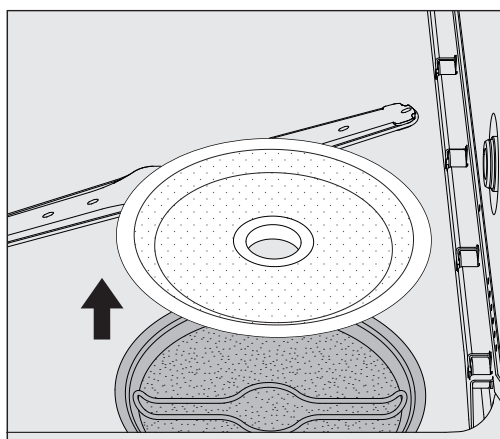

- Remove the coarse filter and rinse under running water.

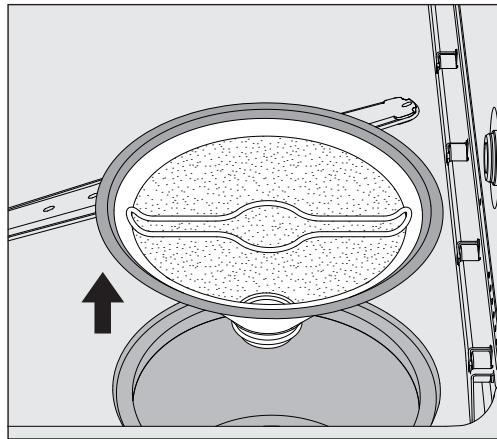

- Remove the microfine screen filter.
- Remove deposits and soiling with running water, using a brush if necessary.
- Blast the microfine screen filter with compressed air against the direction of flow of the wash water.
- Insert the microfine screen filter back into the sump.
- Place the coarse filter on the microfine screen filter.
- Push the holder through the opening in the coarse filter and turn it to the right.

Cleaning the spray arms

Waste particles can lodge in the spray arm nozzles. It is therefore important to inspect the spray arms regularly.

The spray arms of the machine, some mobile units and modules are labelled as follows:

- M1 = Bottom machine spray arm
- M2 = Top machine spray arm
- A1 = A 501, A 504 mobile unit spray arms
- A2 = A 603 module spray arm

Note the label on the spray arms when you reinsert these into the machine, mobile units and modules.

- Use a sharp pointed object to push visible particles into the spray arm nozzles and rinse well under running water.

Remove the spray arms as follows:

Machine spray arms

- Remove any mobile units from the wash chamber.

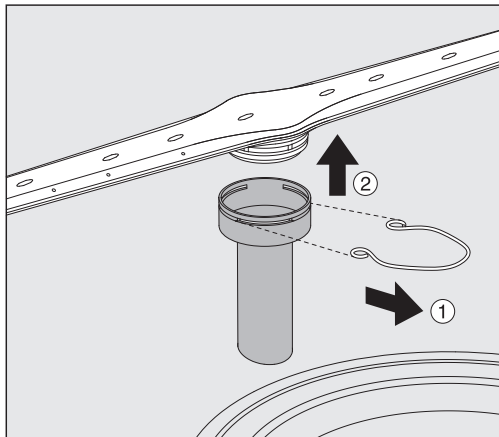

- Loosen the securing clip on the spray arm connection and then pull the lower spray arm upwards and the upper spray arm downwards.
- Loosen the securing clip on the spray arm connection and then pull the spray arm downwards.

Spray arms on mobile units and modules

If there is considerable visible wear on the bearing on the spray arm, contact the Miele Customer Service Department as this can result in functional problems.

- Reinsert the spray arms after cleaning the secure them with the securing clips. Ensure that the securing clips are seated correctly.

After replacing the spray arms, check that they rotate freely.

⚠ Insufficient cleaning results due to an incorrectly measured spray arm speed.

There are powerful magnets at the end of the spray arms. If metallic objects get stuck on these magnets, this can cause a false reading of the spray arm rotation speed.

Remove any metallic objects which are stuck to the magnets, e.g. instrument parts.

Cleaning the machine

Locking the display

The machine display can be locked for cleaning and surface disinfection.

- Press the  button in the header.

The following will appear on the display:

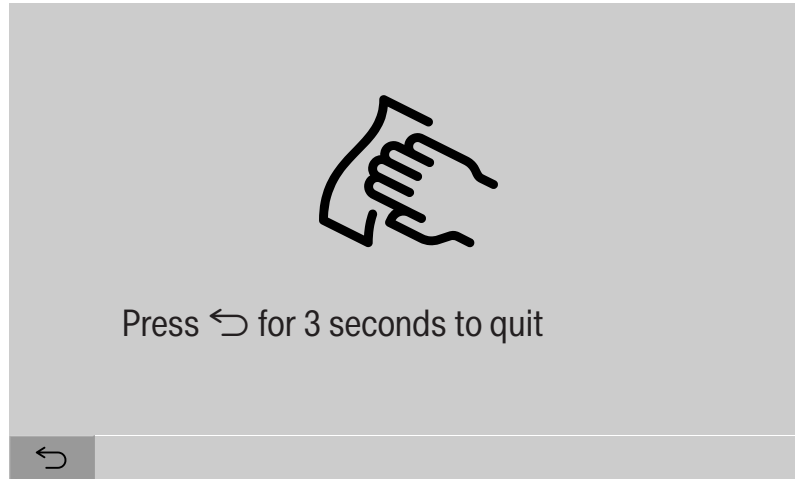

- To unlock the machine display, hold the ↵ button for around 3 s.
- The glass door and the display should only be cleaned with a damp cloth or a suitable cleaning agent designed for use on glass.

Cleaning control elements and the glass door

Do not use abrasives or multi-purpose detergents!
These can cause considerable damage to the glass due to their chemical composition.

Maintenance

- Cleaning the front of the appliance**
- The stainless-steel front should only be cleaned with a damp cloth and a cleaning and disinfecting agent or with a non-abrasive stainless-steel cleaner.
 - To help prevent re-soiling (fingerprints, etc.), a suitable stainless-steel care product can be used after cleaning.

Do not use cleaning agents containing ammonia or thinners!
These agents can damage the surface material.

 Risk of fire due to ingress of water.
The pressure of a water jet can cause water to get into the machine.
Never clean the machine or in its vicinity with a water hose or a pressure washer.

Cleaning the wash chamber

The wash chamber is generally self-cleaning.

- However, should a build-up of deposits occur in the cabinet please contact the Miele Customer Service Department for advice.

Cleaning the door seal

- The door seal should be cleaned regularly with a damp cloth to remove any stains.

Seals which are no longer tight or which have sustained damage must be replaced with new ones by the Miele Customer Service Department.

Checking mobile units, modules and inserts

Mobile units, modules and inserts should be checked daily to make sure they are functioning correctly. A checklist is supplied with the machine.

The following points must be checked:

- Are the guide rails in good condition, and are they securely attached to their mobile units?
- Are the lock nuts for the guide rails tightened securely?
- Are the locking caps in the module connectors of the modular system mobile units working properly?
- Are all injector nozzles, irrigation sleeves and hose adapters securely attached to mobile units or inserts?
- Are all injector nozzles, irrigation sleeves and hose adapters clear so that wash water can flow through unhindered?
- Are all caps and fasteners securely attached to the irrigation sleeves?

If spray arms are present:

- Do the spray arms rotate freely?
- Are the spray arm nozzles free from blockages (see “Maintenance” – “Cleaning the spray arms”)?
- Are the magnets present at the end of the spray arms?
- Are the magnets at the end of the spray arms free from metallic objects?

Mobile units, modules and inserts must be inspected periodically together with the machine after 2000 operating hours or at least once per year, see “Maintenance” – “Periodic checks”.

Built-in printer (optional)

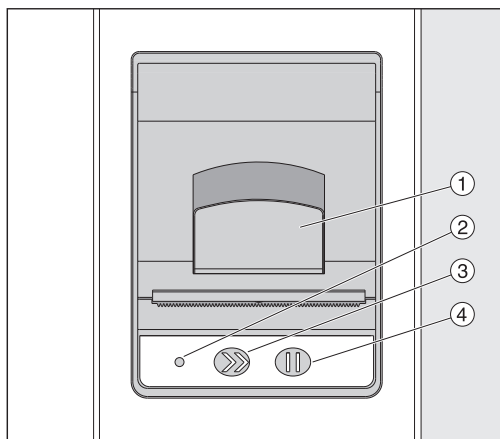

- ① Lever for opening the flap
- ② LED
- ③ Paper feed
- ④ Acknowledgement button

LED status	Printer status
Off	Power supply fault
On	Ready for operation
Flashing x1	Not ready for operation
Flashing x2	Fault on the printer head
Flashing x3	Paper jam/paper roll empty
Flashing x4	Temperature fault

Replacing the paper roll

The paper roll for the built-in printer may not be replaced while a programme is running.

When the LED ② flashes three times, this indicates that the paper roll has run out. To replace the paper roll, proceed as follows:

- Pull the lever ① on the printer flap and lift the flap upwards.
- Take the empty paper roll out of the printer compartment and insert the new paper roll.

The end of the paper roll is on the bottom side of the compartment.

- Pull a bit of the end of the paper out of the compartment and close the printer flap.
- Cut off the protruding strip of paper.
- Press the acknowledgement button ④.

The printing process will continue.

Thermal paper

Replacement rolls of thermal paper with a width of 60 mm and an external diameter of approx. 50 mm can be obtained from the machine manufacturer.

When this is stored under the following conditions, the text will remain legible for at least 7 years:

- Avoid direct light
- Constant room temperature between 18 °C and 25 °C
- Relative humidity of max. 40–60 %

The durability of the thermal printout is reduced by:

- A faulty printer head in the thermal printer
- The thermal printer being set incorrectly; the printout appears faded
- Prolonged exposure to temperatures above 40 °C
- Storage in a damp or wet environment over a long period
- Contact with plasticisers, which are found, for example, in PVC films
- Contact with oils, fats or alcohol
- Contact with aggressive chemicals
- Direct sunlight

Unfavourable conditions will cause the text on the printout to fade. The printout will not be legible and the data to be documented will therefore be lost.

Avoid all influences which will impair the durability of the thermal printout.

Prepare a backup copy on thermostable paper if necessary.

Error messages and instructions

The error messages on the machine display are designed to help you to find the cause of a malfunction and to resolve it. However, please observe the following:

⚠ Repairs may only be performed by the Miele Customer Service Department or an authorised technician.
Unauthorised repairs can expose the user to considerable risk.

Representation of faults on the display

Machine warnings ⚠ and faults ⊗ are shown in the footer of the display. The symbol is used as a button to open the list with all messages.

In main menu

While the main menu is shown in the display, messages are shown in a pop-up window:

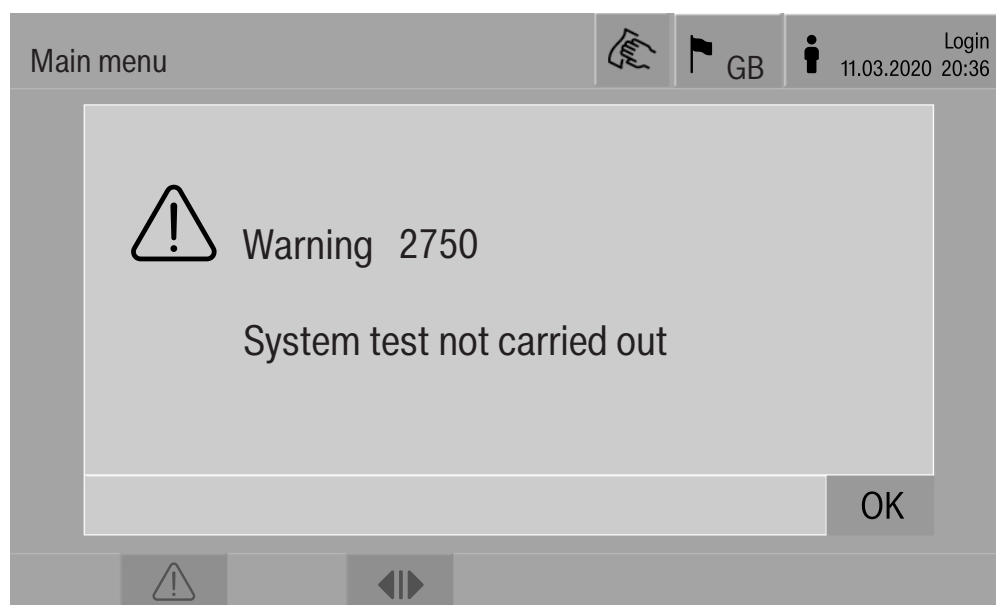

If there are messages for multiple errors and warnings, a pop-up window is shown accordingly.

The pop-up windows are closed by selecting **OK**. The messages remain in the list of active messages.

It may be that an error occurs more than once. If, for example, the system test cannot be carried out for 3 days, 3 pop-up windows are shown with the corresponding message. The pop-up window must be closed 3 times by selecting **OK**.

In the programme sequence

The current message is displayed on the programme sequence display in addition to the progress bar. The colour of the progress bar changes depending on the type of message:

- Yellow for warnings ⚠
- Red for faults ⊗

Technical faults on the machine

List with active messages

Messages		GB	user/USER 18.06.2018 15:05
2650 Seal door gasket timeout	28.01.2019	11:09	OK
2478 Contact fault Load carrier in chamber	28.01.2019	10:32	OK
2841 User ID unknown	28.01.2019	10:11	OK
2750 System test not carried out	28.01.2019	10:06	OK
2687 Peak load cut-out Demineralised water tank	28.01.2019	09:09	OK
2651 Release door gasket timeout	28.01.2019	09:09	OK

After a warning or fault symbol has been pressed in the main menu, the list containing all active messages is shown on the display. If the list contains more than 6 entries, a scroll bar will appear above the footer.

Moving the scroll bar opens the next page of the list.



The date and time of the occurrence are shown in addition to the fault number.

In the right-hand column, the warnings and faults can be acknowledged with **OK**. The buttons are only active when acknowledgement is possible.

Press the button with the message in the left-hand column to open the description of the fault number with information on rectifying the fault.

Error messages and instructions

Troubleshooting

Fault	2841		 GB	 user/USER 18.06.2018 15:05
Description	Confirm message with OK. Check user administration. If fault persists, call Service.			
Machine type	PLW 8617			
Fabrication number	00 / 123456789			

←  OK

After a warning or fault button has been pressed in the message list, the message with information on rectifying the fault is indicated on the display.

Press **OK** to acknowledge the message and exit the menu.

Press ↶ to exit the menu without acknowledging the message.

The message list is shown again on the display.

Technical faults without fault number

Problem	Cause and remedy
The machine display is dark.	<p>The machine display is not showing any information. This can be as a result of the following:</p> <ul style="list-style-type: none"> – The display is faulty – The connecting cable between the display and the controls is faulty – The plug connection is faulty <p>■ Call the Customer Service Department.</p>
	<p>The machine is not switched on.</p> <p>■ Press the I power switch.</p>
	<p>An external residual current device (RCD) has switched.</p> <p>■ Inform building services.</p>
	<p>An external emergency off switch was activated.</p> <p>■ Inform building services.</p>
The wash water in the wash chamber of the machine is not drained after a programme cancellation.	<p>The Drainage after disinfection parameter is enabled in the programme header of the re-processing programme.</p> <p>■ Manually disinfect the wash water and remove it from the wash chamber with the Manual disinfection programme (see “Operation, programme cancellation, programme cancellation with manual disinfection”).</p>

After sales service

 Repairs may only be carried out by the Miele Customer Service Department or an authorised technician.
Unauthorised repairs can expose the user to considerable risk.

To avoid unnecessary service visits, check that the fault has not been caused by incorrect operation when an error message first appears.

Error messages appear on the machine display.

Notify the Miele Customer Service Department if you are still not able to resolve the problem after following the advice on the display.

The Customer Service Department will need to know the model and serial number of the machine. These can be found on the data plate (see “Electrical connection”).

⚠ All electrical work must be carried out by a suitably qualified electrician in accordance with local and national safety regulations.

- The electrical installation must comply with current local and national safety regulations (e.g. DIN VDE 0100 in Germany).
- The connection to the power supply must be via a suitably rated plug and socket and must comply with national regulations. The socket must be accessible after the machine has been installed. An electrical safety test must be carried out after installation and after any maintenance work.
- If the machine is hard-wired to the power supply, a power switch with all-pole isolation must be installed. The power switch must be designed to operate at the rated current for the machine, must ensure a 3 mm gap between all open contacts, and must be able to be locked in the off position.
- Equipotential bonding should be carried out if required.
- The rated loads are specified on the data plate and in the circuit diagram supplied with the machine.
- Check that the phase rotation is correct when connecting the machine. Failure to do so could have an adverse effect on the circulation pump and impair the wash quality.
- For added safety, the machine should be protected by a type B residual current device with a trip current of 30 mA (DIN VDE 0664).

You can find more information on electrical connection in the installation diagram supplied with the machine.

The machine must only be operated with the voltage, frequency and fuse rating shown on the **data plate**.

The **data plate** showing relevant test marks is located behind the service panel on the infeed side of the machine.

The **wiring diagram** is supplied with the machine.

Electromagnetic compatibility (EMC)

The machine has been tested for electromagnetic compatibility (EMC) in accordance with EN 61326-1 and is suitable for operation in commercial environments, such as hospitals, medical practices and laboratories and other similar environments which are connected to the mains power supply.

The machine's high frequency (HF) energy emissions are very low and are therefore unlikely to interfere with other electronic machines in the vicinity.

Flooring in the installation area must be wood, concrete or tiled. Synthetic flooring must be able withstand a relative humidity level of 30 % to minimise the risk of electrostatic discharges.

The quality of the power supply should comply with that found in a typical commercial or hospital environment. Check that the power supply voltage is within a range of +/-10 % (UK: -6/+10 %) of its nominal value.

 Health risk and risk of damage due to contaminated incoming water.

The quality of the incoming water must correspond to the drinking water specification of the country in which the machine is being operated.

Please refer to the installation diagram supplied with the machine.

- If the water supply has a high iron content, there is a danger that corrosion may occur on load items and the machine itself.
- If the chloride content of the water exceeds 100 mg/l, the risk of corrosion to items being cleaned in the machine will be increased further.
- In certain regions, the water composition may cause precipitates to form, requiring the use of softened water in the steam condenser.

Technical data

Height	2495 mm
Width	1150 mm
Depth	990 mm
Useable cabinet dimensions:	
Height	675 mm
Width	650 mm
Depth	800 mm
Net weight including plinth and top-box panelling	477 kg
Net weight including EL/S, DU, SC, CT *	667 kg
Operating weight	902 kg
Distributed load (max. load-bearing capacity)	7.8 kN/m ²
Voltage, rated load, fuse rating	See data plate
Compressed air connection:	
Technical to ISO 8673-1: Class 4	600-800 kPa
Steam connection (optional):	
Quality	Dry industrial steam
Steam pressure	250-1000 kPa
Water temperature of water connection:	
Cold water/steam condenser	5-20 °C
Hot water/DI water	5-65 °C
Water connection pressure	200-1000 kPa
Operating conditions:	
Ambient temperature	5-40 °C
Relative humidity	
Minimum	10 %
Maximum for temperatures up to 31 °C	80 %
Linear decreasing for temperatures up to 40 °C	50 %
Storage and transportation conditions:	
Ambient temperature	-20 to +60 °C
Relative humidity	10-85 %
Air pressure	500-1060 hPa
Max. altitude above sea level	2000 m**
Protection category (according to IEC 60529)	IP 20
Degree of soiling (according to IEC/EN 61010-1)	P2
Overvoltage category (according to IEC 60664)	II
Sound pressure level LpA during cleaning and drying	<65 dB(A) re 20 µPa
Test certifications	VDE, radio and television suppressed
CE marking	2006/42/EC Machinery Directive
Manufacturer address	Miele & Cie. KG, Carl-Miele-Str. 29, 33332 Gütersloh, Germany

* See the installation plan for optional extras

*** If installed above 1500 m, the boiling point of the wash water will be lower. In this case, the disinfection temperature and the holding time might need to be adjusted.

Disposing of the packaging material

The packaging material is used for handling and protects the appliance from transport damage. The packaging material used is selected from materials which are environmentally friendly for disposal and can generally be recycled.

Recycling the packaging material reduces the use of raw materials. Use material-specific collection points for valuable materials and take advantage of return options. Your Miele dealer will take the packaging material away.

Disposing of your old appliance

Electronic and electrical appliances contain many valuable materials. They also contain certain materials, compounds and components which were essential for their correct functioning and safety. These could be hazardous to your health and to the environment if disposed of with general waste or if handled incorrectly. Please do not, therefore, dispose of your old appliance with general waste.

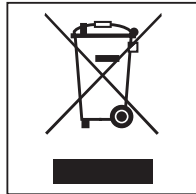

Instead, please make use of officially designated collection and disposal points to dispose of and recycle electrical and electronic appliances in your local community, with your dealer, with Miele or with the manufacturer. By law, you are solely responsible for deleting any personal data from the appliance prior to disposal. You are legally obliged to remove any old batteries which are not securely enclosed by the appliance and to remove any lamps without destroying them, where this is possible. These must be taken to a suitable collection point where they can be handed in free of charge. Please ensure that your old appliance poses no risk to children while being stored prior to disposal.



Appendix

Appendix

User rights in the Main menu

Action	Without login	Automatic	Operator	Technician	Administrator
Open and close the loading door	●	●	●	●	●
Open and close the unloading door after the end of a programme depending on the Authentication - End of programme setting in the web interface	●	●	●	●	●
Select the electric or steam heating method (see “Machine description”)	●	●	●	●	●
Change the display language	●	●	●	●	●
Close popups with messages depending on the type of message, warning or error message	●	●	●	●	●
Change the screen view in the current programme (see “Machine description”)	●	●	●	●	●
Select and start programme (see “Operation”) depending on the settings in the web interface under programme administration		●	●	●	●
Cancel the programme (see “Operation”)	●	●	●	●	●
Print out process documentation			●	●	●

User rights in the System menu

Main menu/System		Without login	Automatic	Operator	Technician	Administrator
Network connections	Change PIN		●	●	●	●
	Pairing				●	●
	Network				●	●
	Printer				●	●
	Certificate presentation				●	●
Machine functions	Self-disinfection			●	●	●
	Iterative programme					●
	Fill dispensing system			●	●	●
	Filter maintenance				●	●
	Set up dispensing system				●	●
	Adjust conductivity meter				●	●
	Programme test					●
Restart			●	●	●	
Data plate				●	●	
Manage favourites					●	

Appendix

Power levels of the programmes/mobile units/module combinations

Mobile unit	Modules	Programmes/power levels
A 500	- A 603	Mini Standard Universal Intensive Organic Inorganic Oil Agar Plastics Disin 93/10
A 501		Mini Plus Standard Plus Universal Plus Intensive Plus Organic Plus Inorganic Plus Oil Plus Agar Plus Plastics Plus Disin 93/10 Plus
A 503	- 1–3 x A 605 A 605 modules can be replaced with A 620 modules, for example	Vials
A 503	- 4–6 x A 605 A 605 modules can be replaced with A 620 modules, for example	Vials Plus
A 503	- 1 x A 613 Plus a maximum of 4 other modules, e.g. A 620	Pipettes 1
A 503	- 2 x A 613 Plus a maximum of 2 other modules, e.g. A 620	Pipettes 2
A 503	- 3 x A 613 No extra modules can be added	Pipettes 3

Mobile unit	Modules	Programmes/power levels
A 503	1–3 modules: - A 606 - A 612 - A 620 - A 621 - A 622 - A 623	Mini Standard Universal Intensive Organic Inorganic Oil Agar Plastics Disin 93/10
A 503	4–6 modules: - A 606 - A 612 - A 620 - A 621 - A 622 - A 623	Mini Plus Standard Plus Universal Plus Intensive Plus Organic Plus Inorganic Plus Oil Plus Agar Plus Plastics Plus Disin 93/10 Plus
A 503	1–6 modules	Drying
A 505 A 506 A 508 E 900-4/2 E 900-5/2 E 935/2 E 940 E 950/1 E 957 E 975/2		Mini Plus Standard Plus Universal Plus Intensive Plus Organic Plus Inorganic Plus Oil Plus Agar Plus Plastics Plus Disin 93/10 Plus

Appendix

Mobile unit	Modules	Programmes/power levels
E 941	<ul style="list-style-type: none"> - 1-4 E 943/2 - 1-4 E 944/2 - 1-2 E 945/2 + 2 extra modules: E 943/2 or E 944/3 	<ul style="list-style-type: none"> Mini Plus Standard Plus Universal Plus Intensive Plus Organic Plus Inorganic Plus Oil Plus Agar Plus Plastics Plus Disin 93/10 Plus
E 941	- 1-4 E 947/2	Vials Plus

If the E 942/3 modules are to be used for pipettes, please contact Miele.

Service programmes

Mobile units	Modules	Power levels/ programme
Zero	- Without modules	Empty tank
All mobile units	- Without restriction	Manual disinfection

Power levels of the programmes/Mobile units/Module combinations for the APLW 511

Programmes with “Max” power level must be entered manually in the web interface as Customer programmes in the  Programme management. To do this, copy the corresponding programme from the Plus power level and adjust the programme parameters.

Programmes with the other two power levels must be adjusted in line with the water consumption of the APLW 511. To do this, copy the corresponding programme and increase the volume of water by 1–2 l/Block with the +/- Water programme parameter.

Mobile unit	Modules	Programmes/power levels
APLW 511	1–3 modules: - A 620 - A 621 - A 622	Mini Standard Universal Intensive Organic Inorganic Oil Agar Plastics Disin 93/10
APLW 511	4–6 modules: - A 620 - A 621 - A 622	Mini Plus Standard Plus Universal Plus Intensive Plus Organic Plus Inorganic Plus Oil Plus Agar Plus Plastics Plus Disin 93/10 Plus
APLW 511	7–9 modules: - A 620 - A 621 - A 622	Mini Max Standard Max Universal Max Intensive Max Organic Max Inorganic Max Oil Max Agar Max Plastics Max Disin 93/10 Max

Optional extras

Features	Standard	Version
Drain valve (DV)	X	
Electric heating (EL)	X	
Conductivity monitoring (CS)	X	
Spray arm monitoring (RS)	X	
Option to switch between steam/electric heating for wash cabinet and VE tank (if present) (EL/S)		X
Recycling tank (RT)		X
VE tank (TH)		X

Additional options:

1–4 additional internal dispensing systems (DS)
Drain pump (DP)
Steam condenser (SC)*
Built-in printer for process documentation (PR)
Drying unit (DU)

* Only in combination with a drying unit

United Kingdom

Miele Co. Ltd., Fairacres, Marcham Road
Abingdon, Oxon, OX14 1TW
Professional Sales, Tel: 0845 365 6608
E-mail: professional@miele.co.uk
Internet: www.miele.co.uk/professional

Australia

Miele Australia Pty. Ltd.
ACN 005 635 398, ABN 96 005 635 398
Level 4, 141 Camberwell Road, Hawthorn East, VIC 3123
Tel: 1300 731 411
Internet: www.miele.com.au/professional
E-mail: sales@miele-professional.com.au

China Mainland

Miele Electrical Appliances Co., Ltd.
1-3 Floor, No. 82 Shi Men Yi Road
Jing' an District, 200040 Shanghai, PRC
Tel: +86 21 6157 3500, Fax: +86 21 6157 3511
E-mail: info@miele.cn, Internet: www.miele.cn

Hong Kong, China

Miele (Hong Kong) Ltd.
41/F - 4101, Manhattan Place
23 Wang Tai Road, Kowloon Bay, Hong Kong
Tel: (852) 2610 1025, Fax: (852) 3579 1404
Email: customerservices@miele.com.hk
Website: www.miele.hk

India

Miele India Pvt. Ltd.
1st Floor, Copia Corporate Suites,
Commercial Plot 9, Mathura Road, Jasola,
New Delhi - 110025
E-mail: customercare@miele.in, Website: www.miele.in

Ireland

Miele Ireland Ltd.
2024 Bianconi Ave., Citywest Business Campus, Dublin 24
Tel: (01) 461 07 10, Fax: (01) 461 07 97
E-Mail: info@miele.ie, Internet: www.miele.ie

Malaysia

Miele Sdn Bhd
Suite 12-2, Level 12
Menara Sapura Kencana Petroleum
Solaris Dutamas No. 1, Jalan Dutamas 1
50480 Kuala Lumpur, Malaysia
Phone: +603-6209-0288
Fax: +603-6205-3768

New Zealand

Miele New Zealand Limited
IRD 98 463 631
8 College Hill
Freemans Bay, Auckland 1011, NZ
Tel: 0800 464 353
Internet: www.miele.com.au/professional
E-mail: sales@miele-professional.com.au

Singapore

Miele Pte. Ltd.
29 Media Circle, #11-04 ALICE@Mediapolis
Singapore 138565
Tel: +65 6735 1191, Fax: +65 6735 1161
E-Mail: info@miele.com.sg
Internet: www.miele.sg

South Africa

Miele (Pty) Ltd
63 Peter Place, Bryanston 2194
P.O. Box 69434, Bryanston 2021
Tel: (011) 875 9000, Fax: (011) 875 9035
E-mail: info@miele.co.za
Internet: www.miele.co.za

United Arab Emirates

Miele Appliances Ltd.
Showroom 1, Eiffel 1 Building
Sheikh Zayed Road, Umm Al Sheif
P.O. Box 114782 - Dubai
Tel. +971 4 3044 999, Fax. +971 4 3418 852
800-MIELE (64353)
E-Mail: info@miele.ae, Website: www.miele.ae



Manufacturer: Miele & Cie. KG
Carl-Miele-Straße 29, 33332 Gütersloh, Germany